

Re scacchi in 2D

VISTA FRONTALE

01

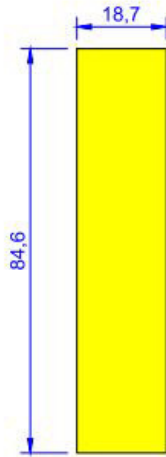

02

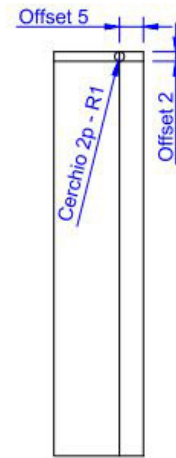

03

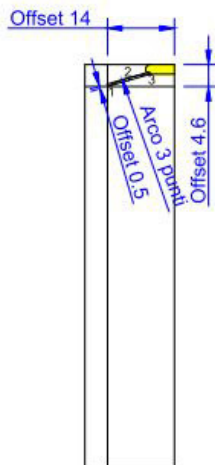

04

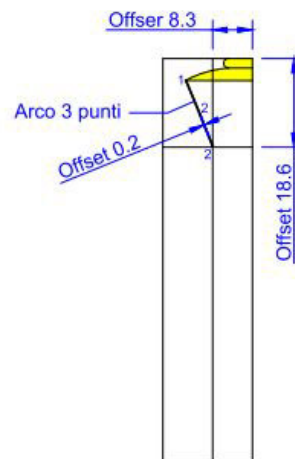

05



06



Re scacchi in 2D

VISTA FRONTALE

07

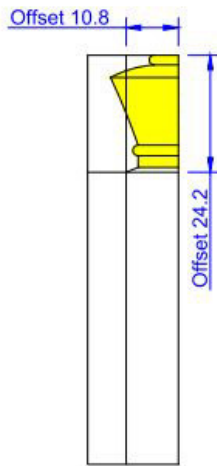

08

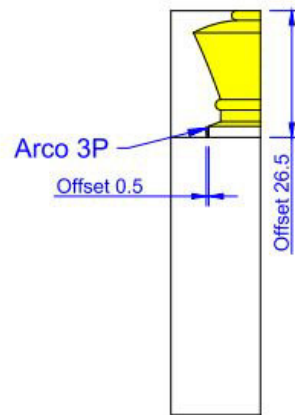

09

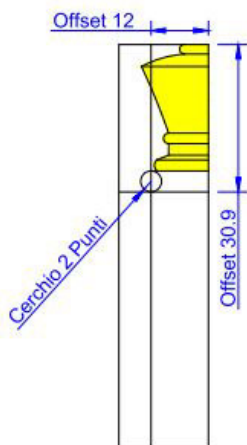

10

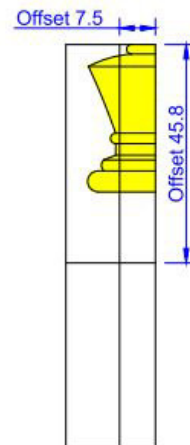

11

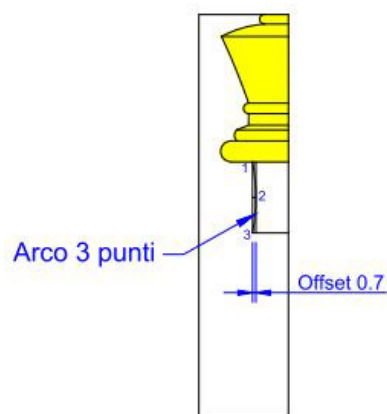

12

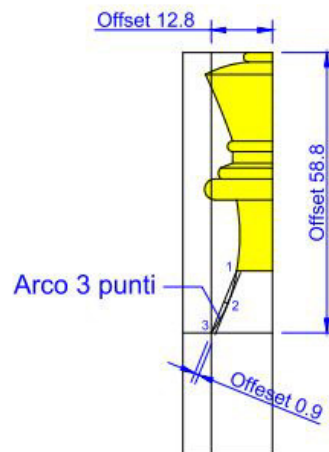

Re scacchi in 2D

VISTA FRONTALE

13

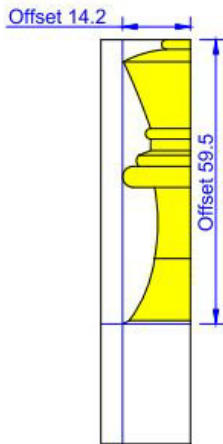

14

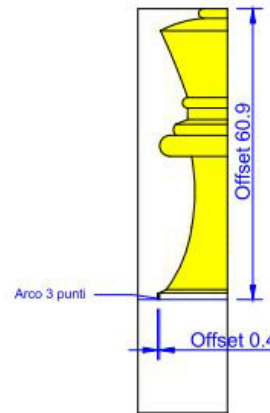

15

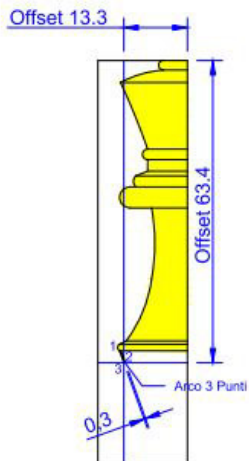

16

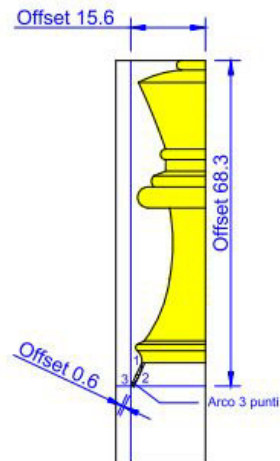

17

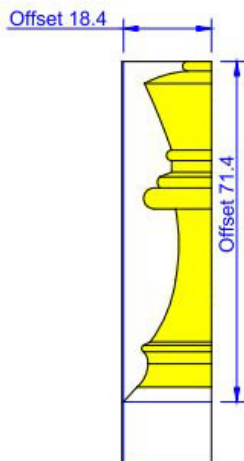

18

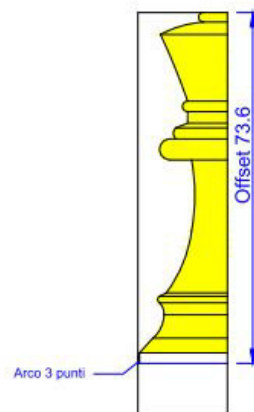

Re scacchi in 2D

VISTA FRONTALE

19

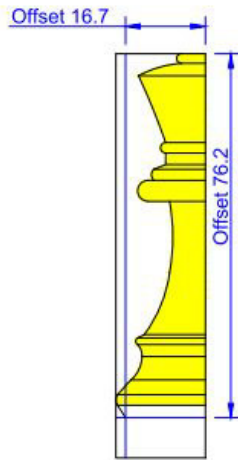

20

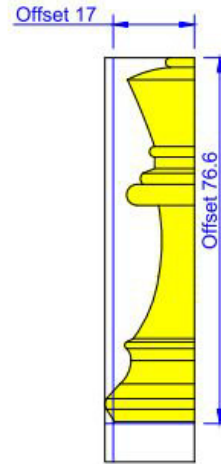

21

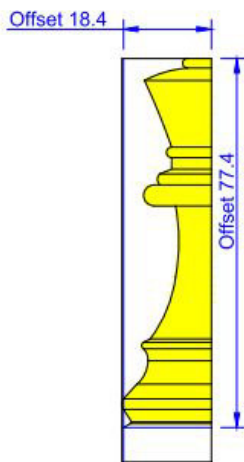

22

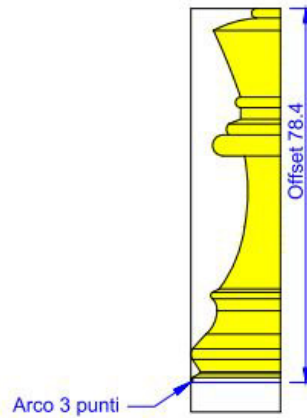

23

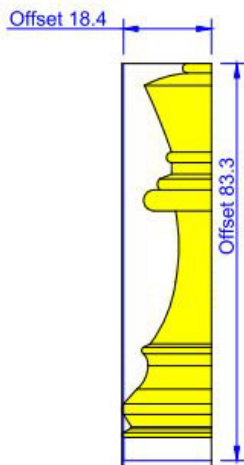

24

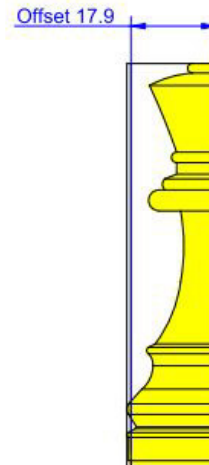

Re scacchi in 2D

VISTA FRONTALE

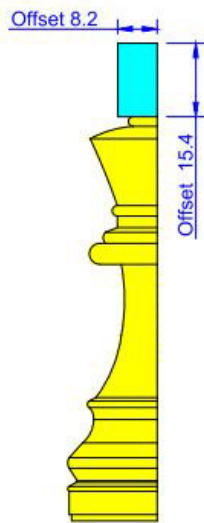

25

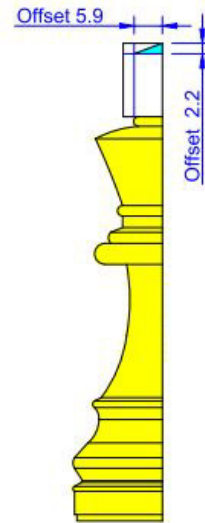

26

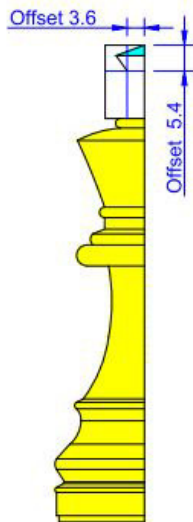

27

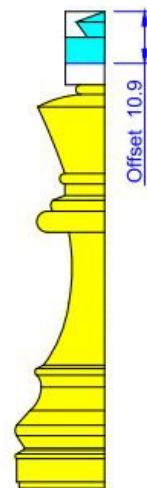

28

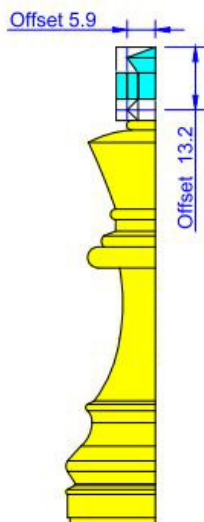

29



30

Re scacchi in 2D

VISTA FRONTALE

31



32

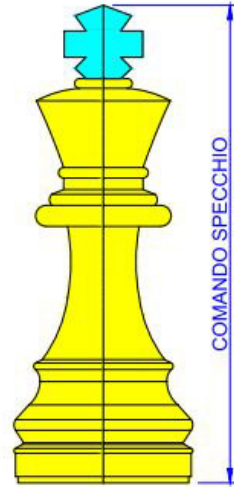

33

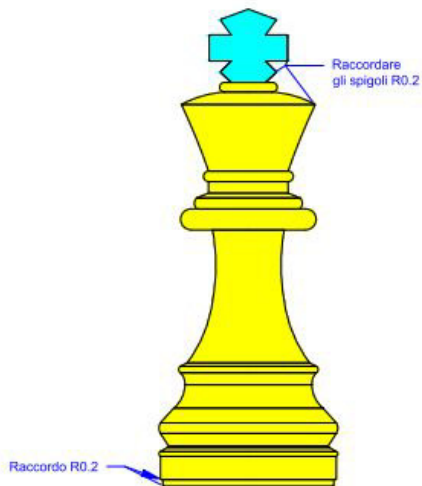

34

