

Torre degli scacchi in 2D

VISTA FRONTALE



Torre degli scacchi in 2D

VISTA FRONTALE

01

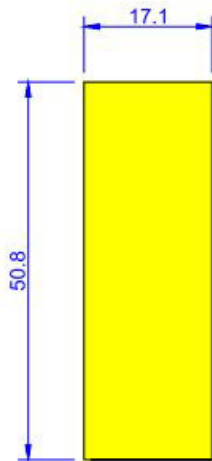

02

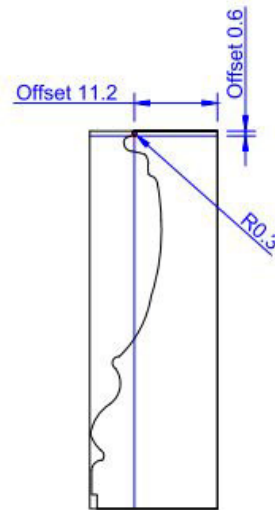

03

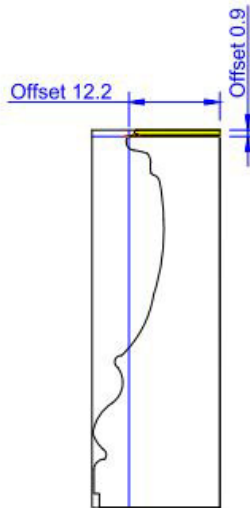

04

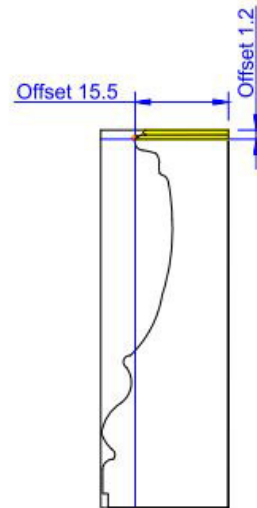

05

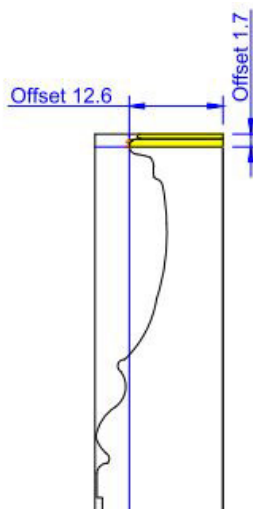

06

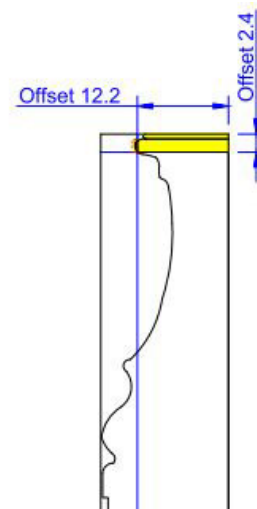

Torre degli scacchi in 2D

VISTA FRONTALE

07

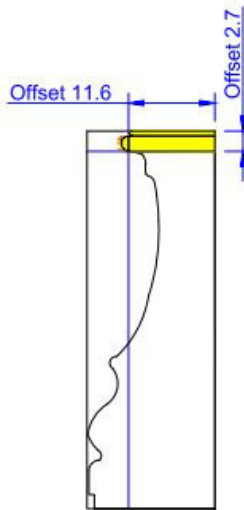

08

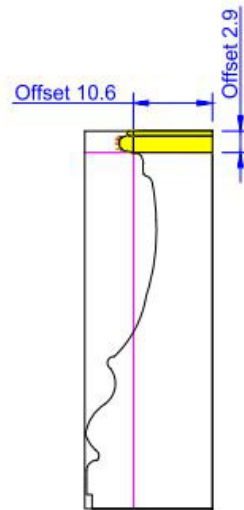

09

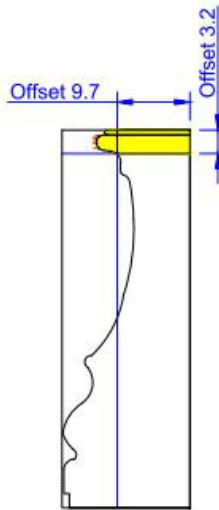

10

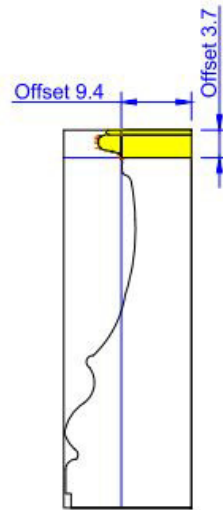

11

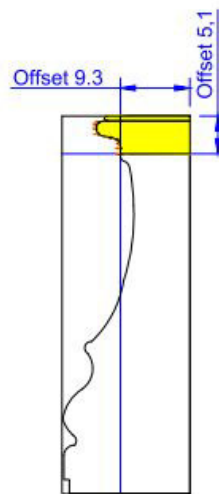

12

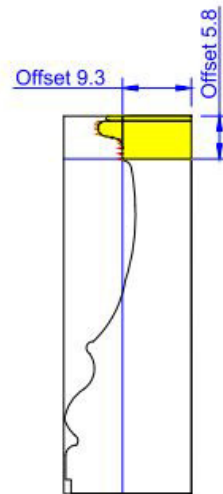

Torre degli scacchi in 2D

VISTA FRONTALE

13

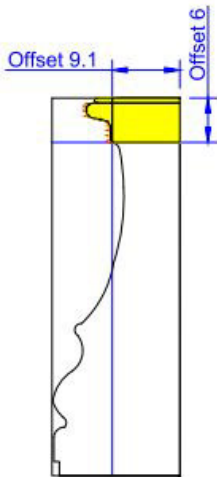

14

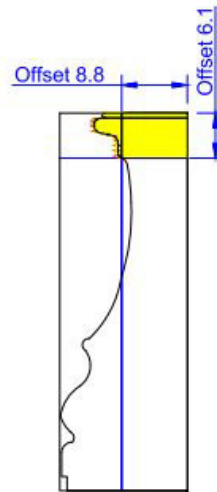

15

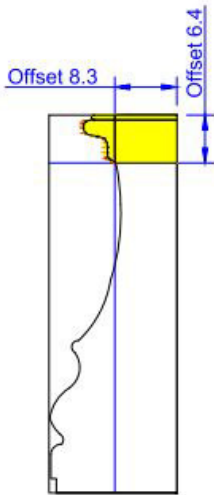

16

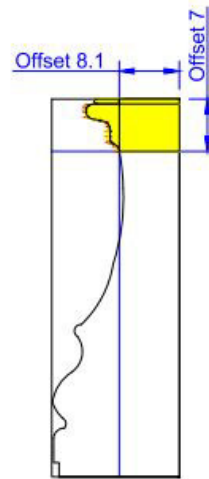

17

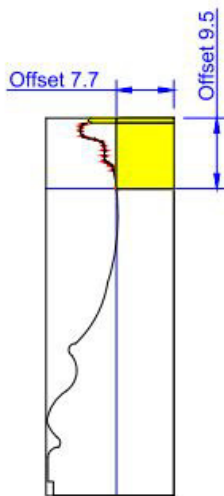

18

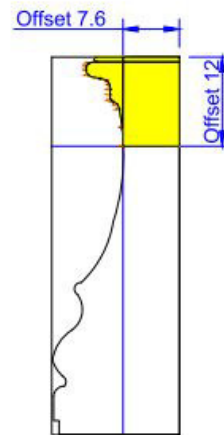

Torre degli scacchi in 2D

VISTA FRONTALE

19

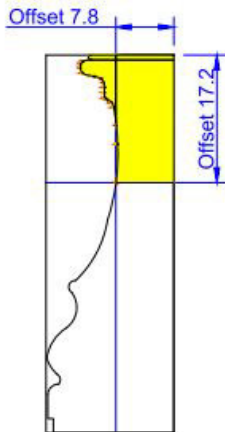

20

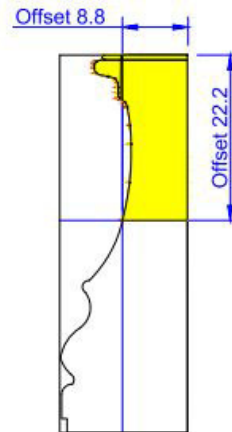

21

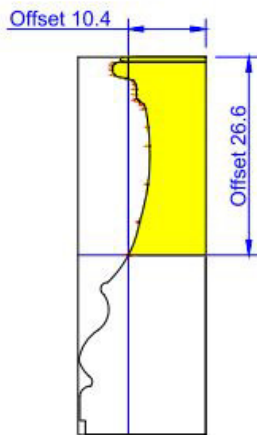

22

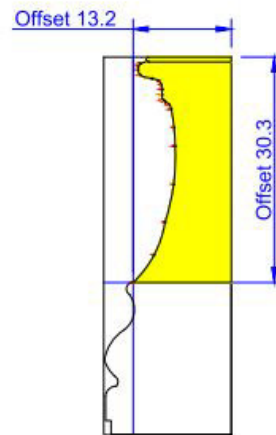

23

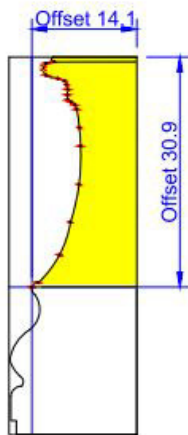

24

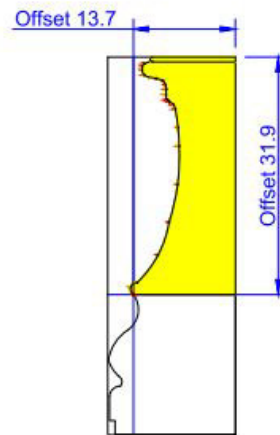

Torre degli scacchi in 2D

VISTA FRONTALE

25

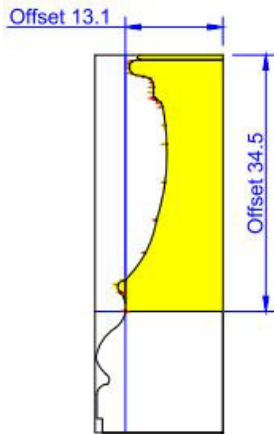

26

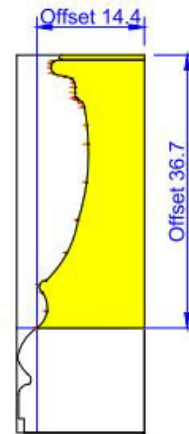

27

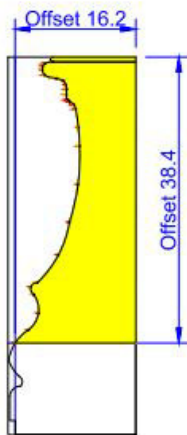

28

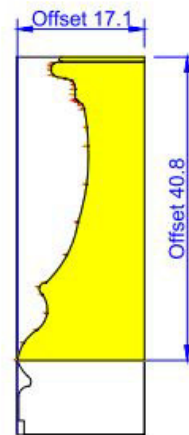

29

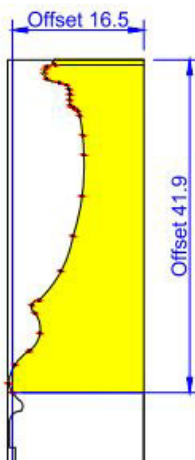

30

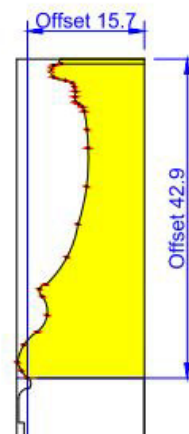

Torre degli scacchi in 2D

VISTA FRONTALE

31

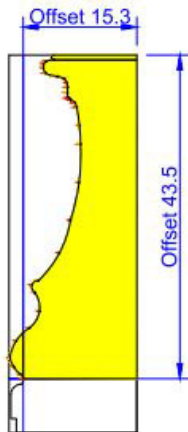

32

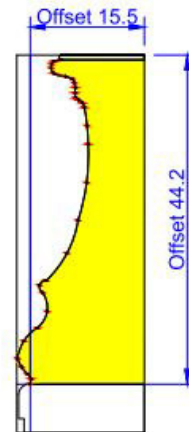

33

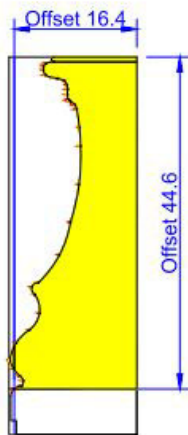

34

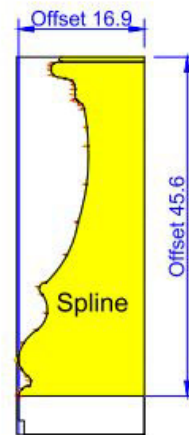

35

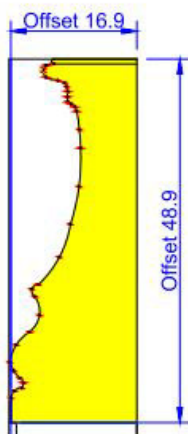

36

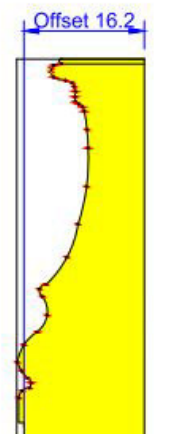

Torre degli scacchi in 2D

VISTA FRONTALE

37

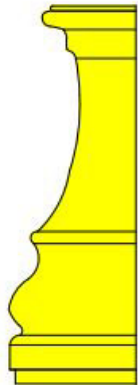

Specchio

38

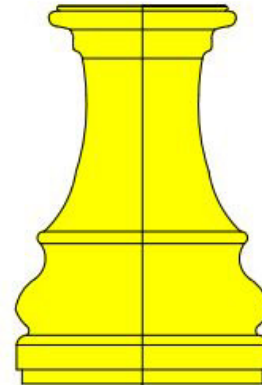

Cancellare asse

39

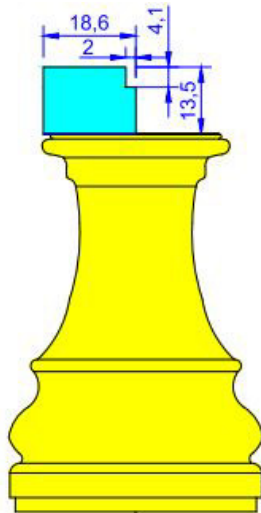

40

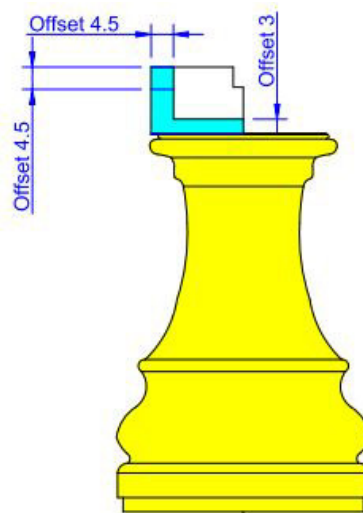

41

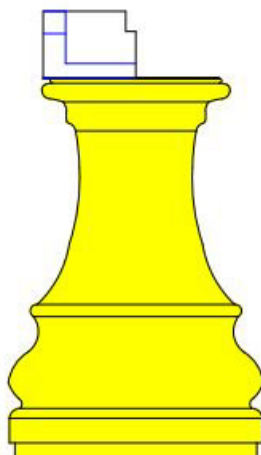

Tratteggiare le linee blu che non si vedono

42

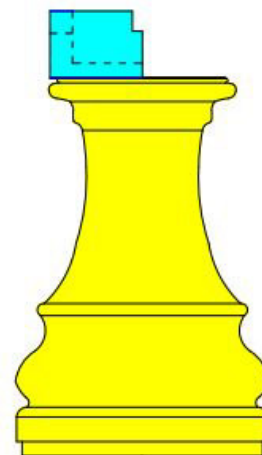

SPECCHIO

Torre degli scacchi in 2D

VISTA FRONTALE

43

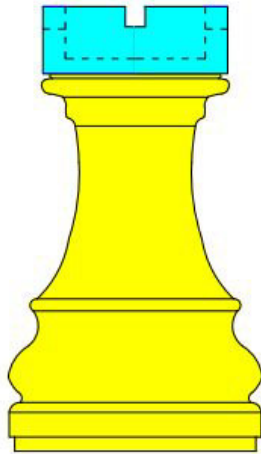

Cancella l' asse

44

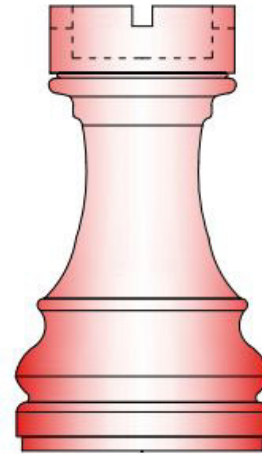

Colorare a piacimento

