

# Bracciale in 2D

Prof. Pisani Antonio

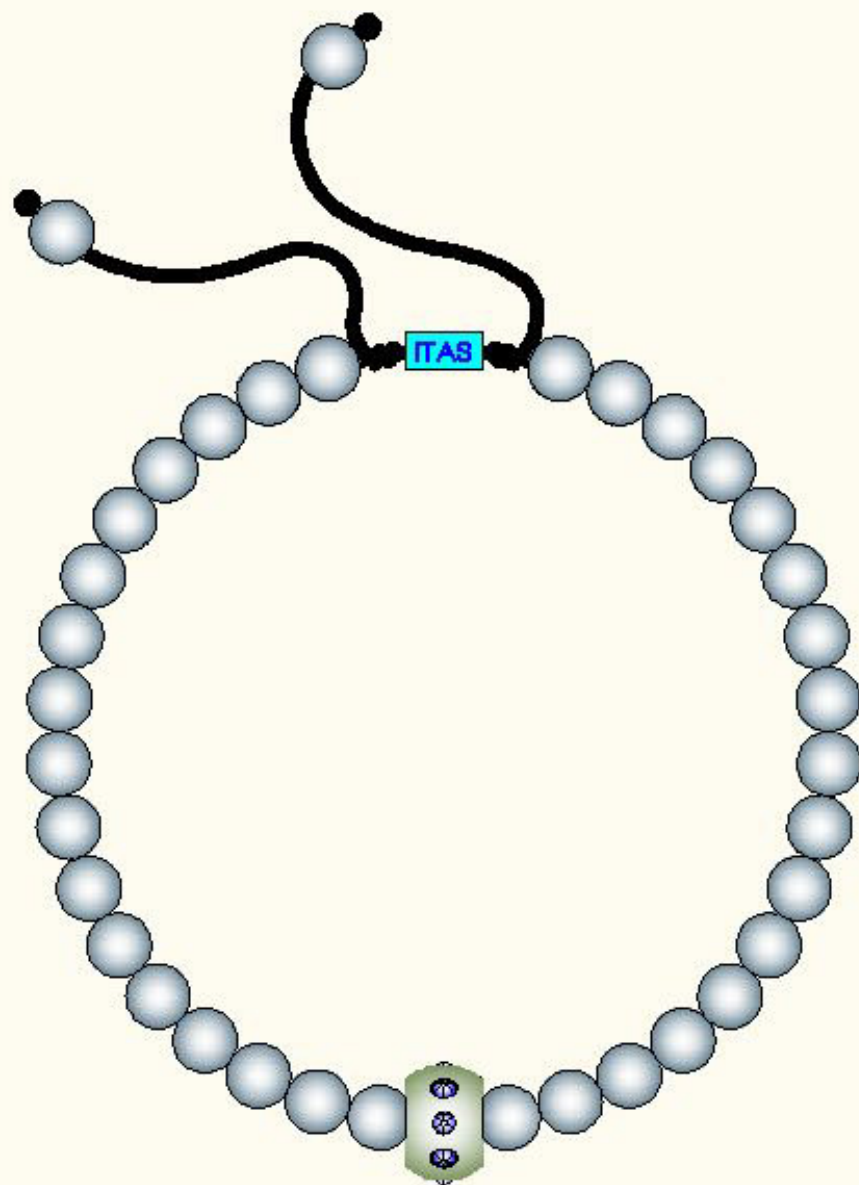

# Bracciale in 2D

VISTA DALL' ALTO

Prof. Pisani Antonio

01

- 1) C. Linea
- 2) C. Cerchio

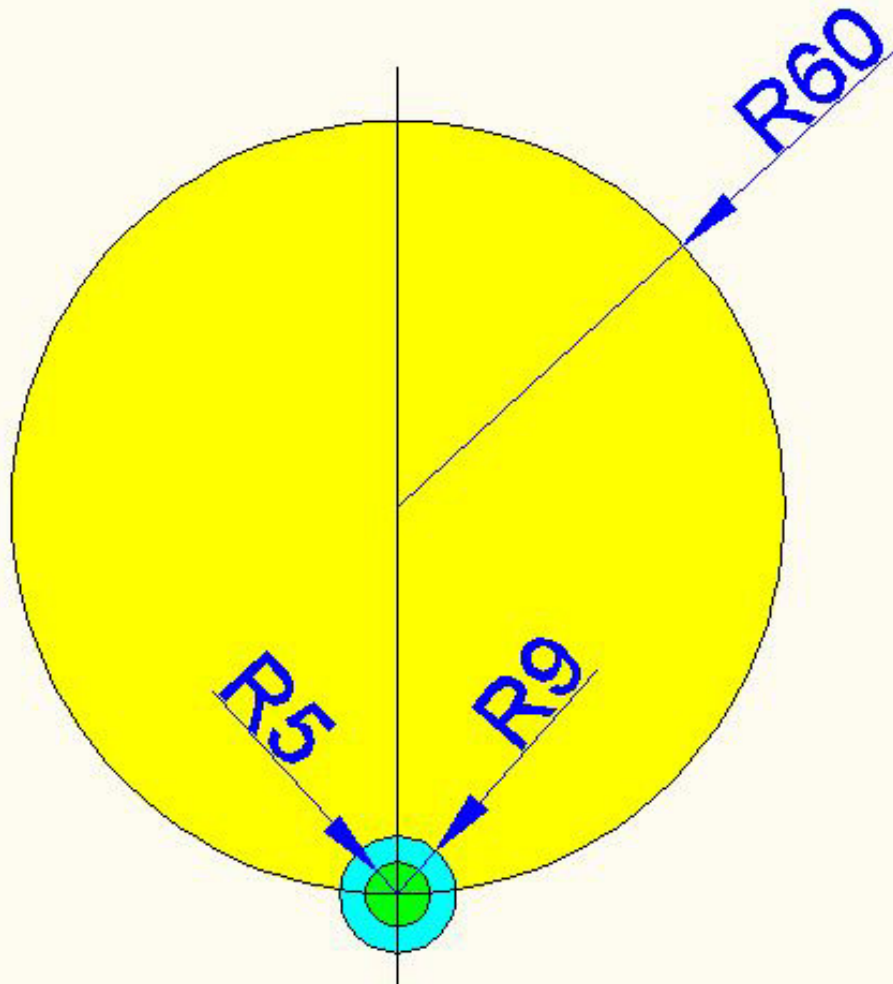

# Bracciale in 2D

VISTA DALL' ALTO

Prof. Pisani Antonio

02

1) C. Offset

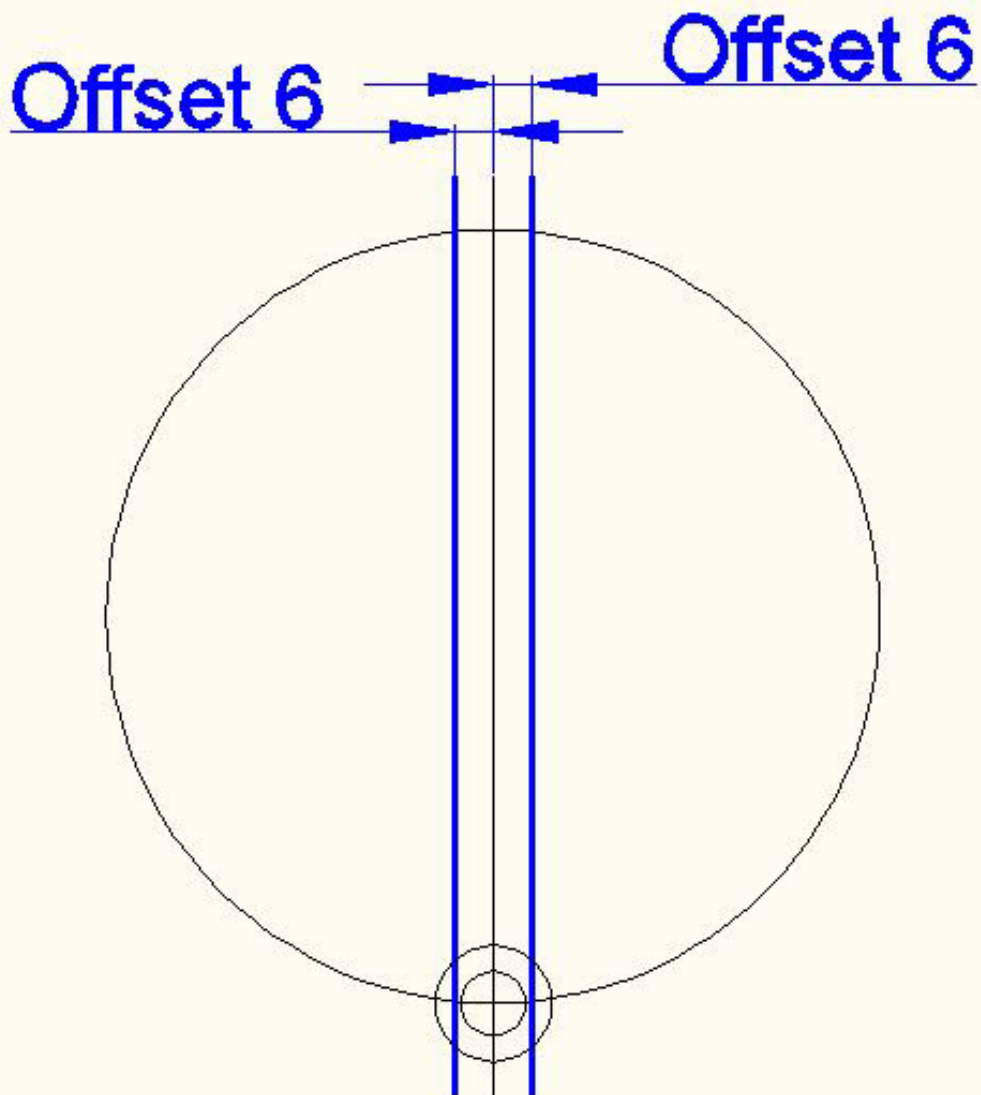

# Bracciale in 2D

VISTA DALL' ALTO

Prof. Pisani Antonio

03

1) C. TAGLIA —

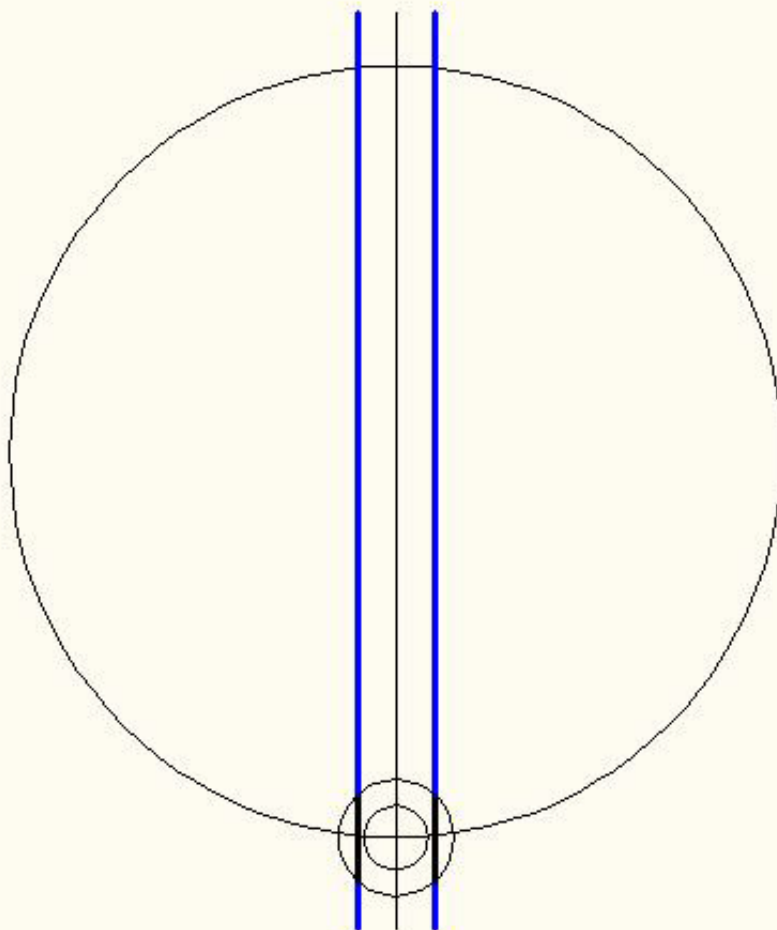

# Bracciale in 2D

VISTA DALL' ALTO

Prof. Pisani Antonio

04

1) C. TAGLIA —

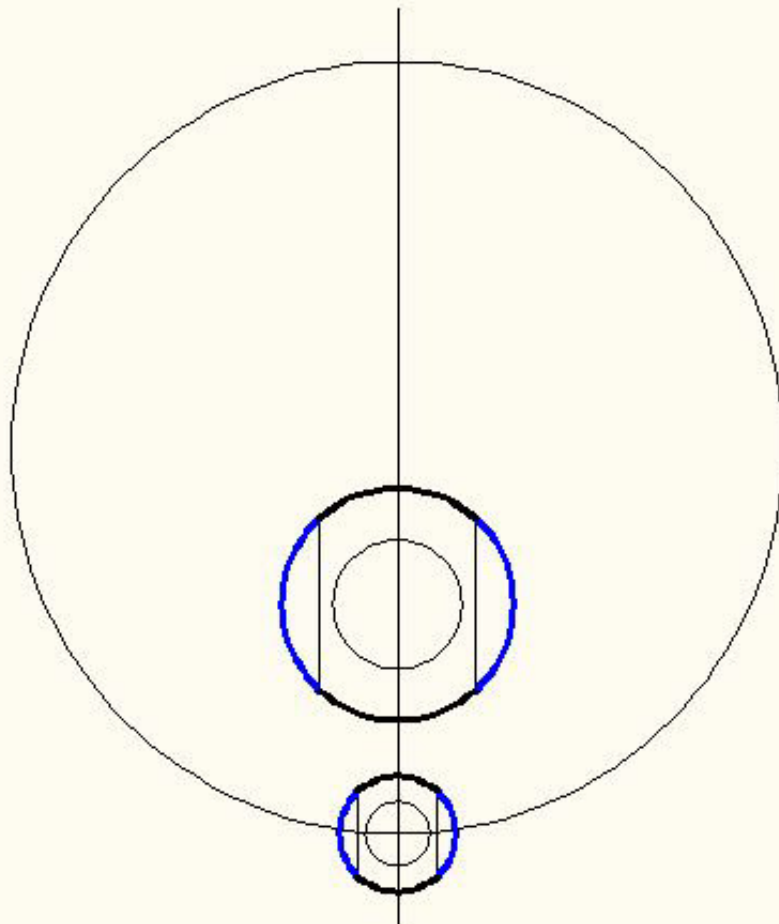

# Bracciale in 2D

VISTA DALL' ALTO

Prof. Pisani Antonio

05

1) C. SERIE POLARE

Nr. oggetti 18

Angolo riempimento 162.5°

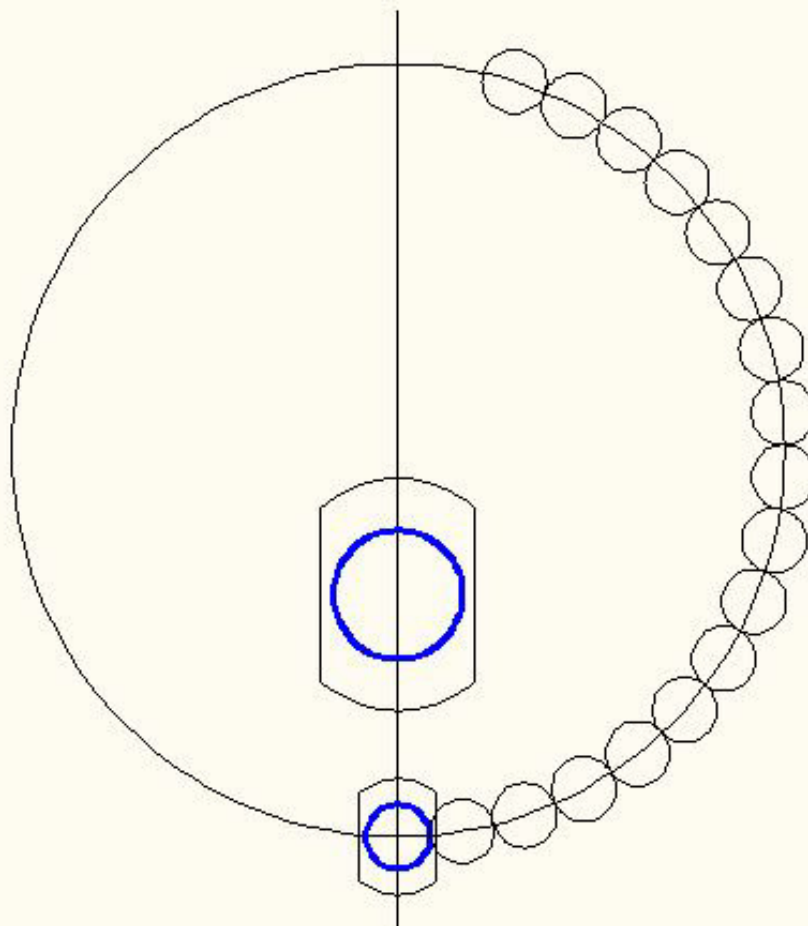

# Bracciale in 2D

VISTA DALL' ALTO

Prof. Pisani Antonio

06

1) C. SERIE POLARE

Nr. oggetti 18

Angolo riempimeto  $-162.5^\circ$

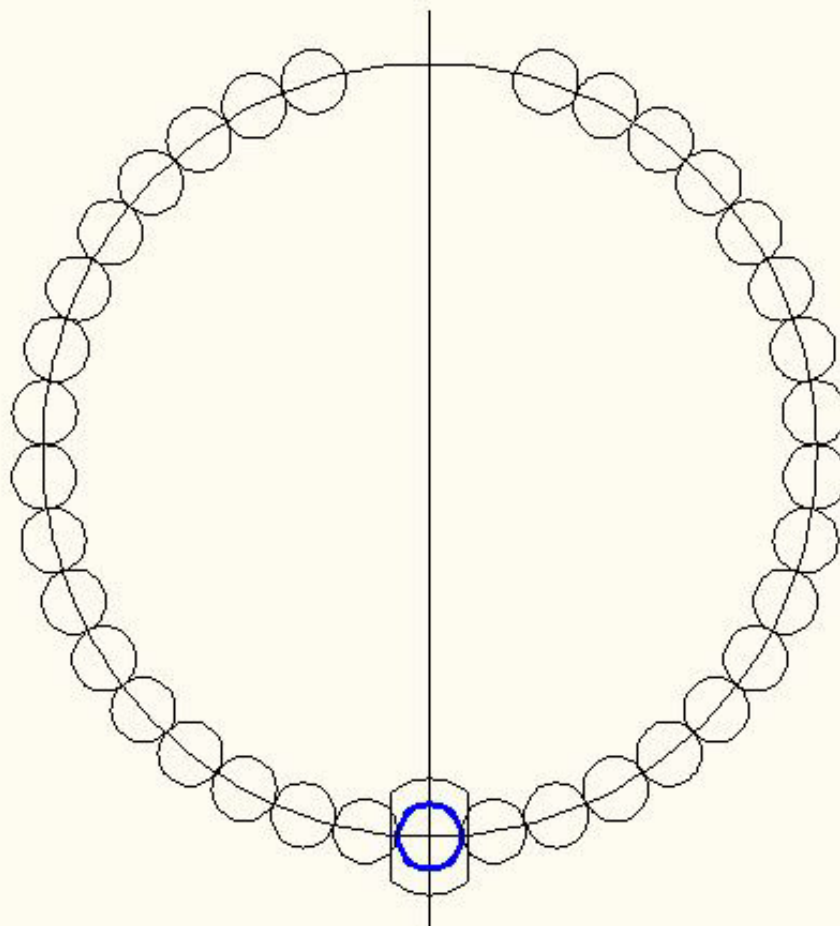

# Bracciale in 2D

VISTA DALL' ALTO

Prof. Pisani Antonio

07

1) C. CANCELLA ———

2) C. TAGLIA ———

3) C. RETTANGOLO 12x6 

spostare al punto A

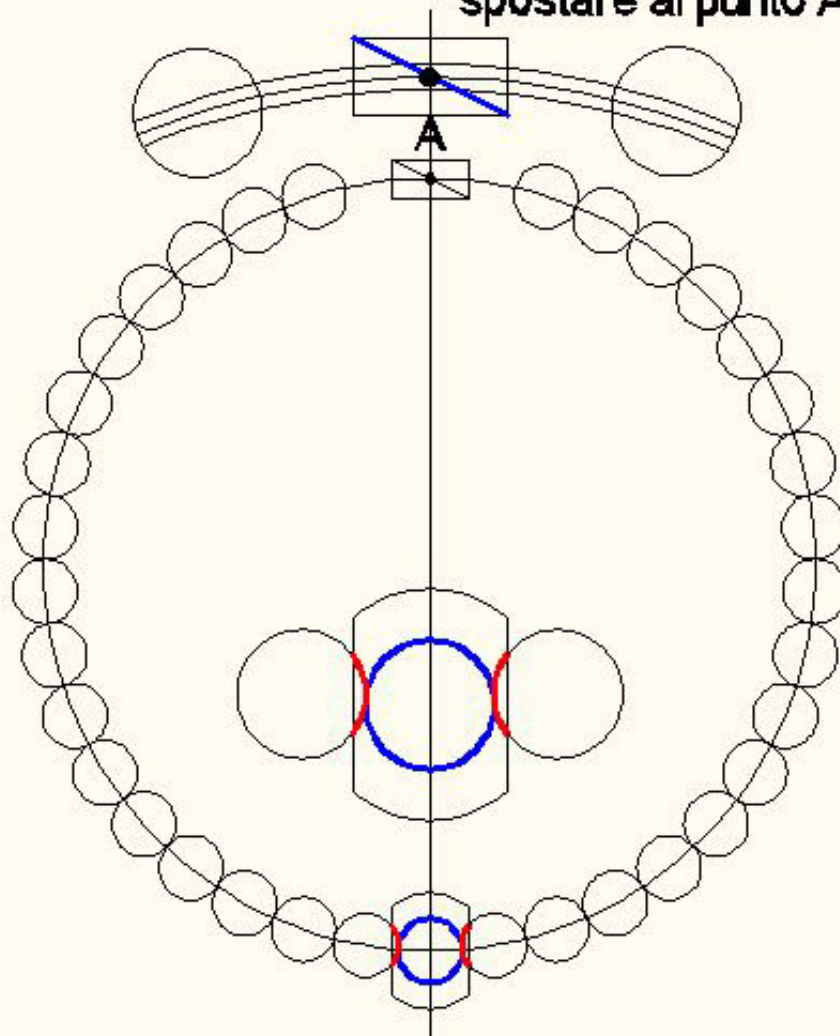



# Bracciale in 2D

VISTA DALL' ALTO

Prof. Pisani Antonio

08

- 1) C. CANCELLA ———
- 2) C. OFFSET ———

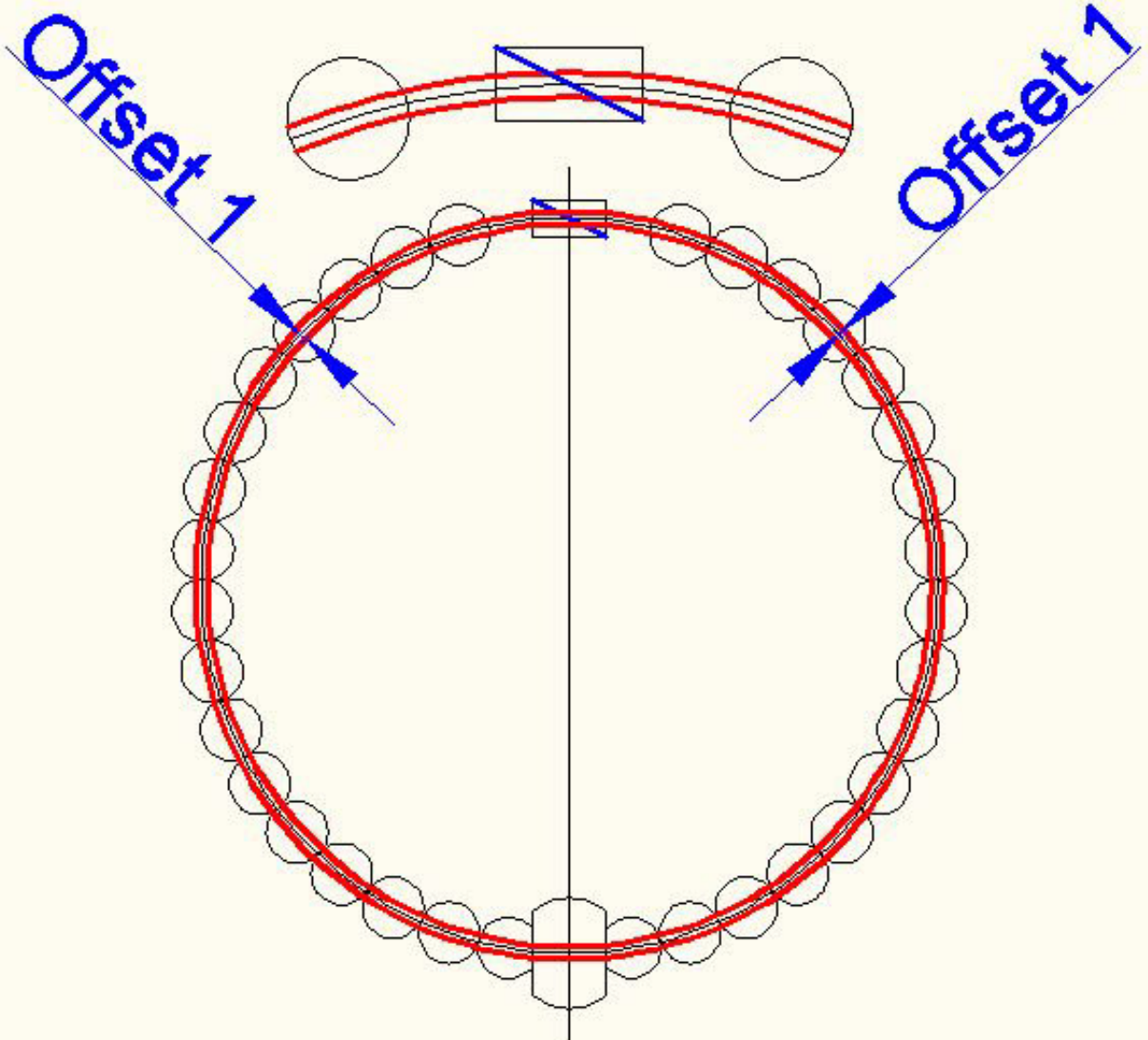

# Bracciale in 2D

VISTA DALL' ALTO

Prof. Pisani Antonio

09

- 1) C. CANCELLA —
- 2) C. OFFSET —

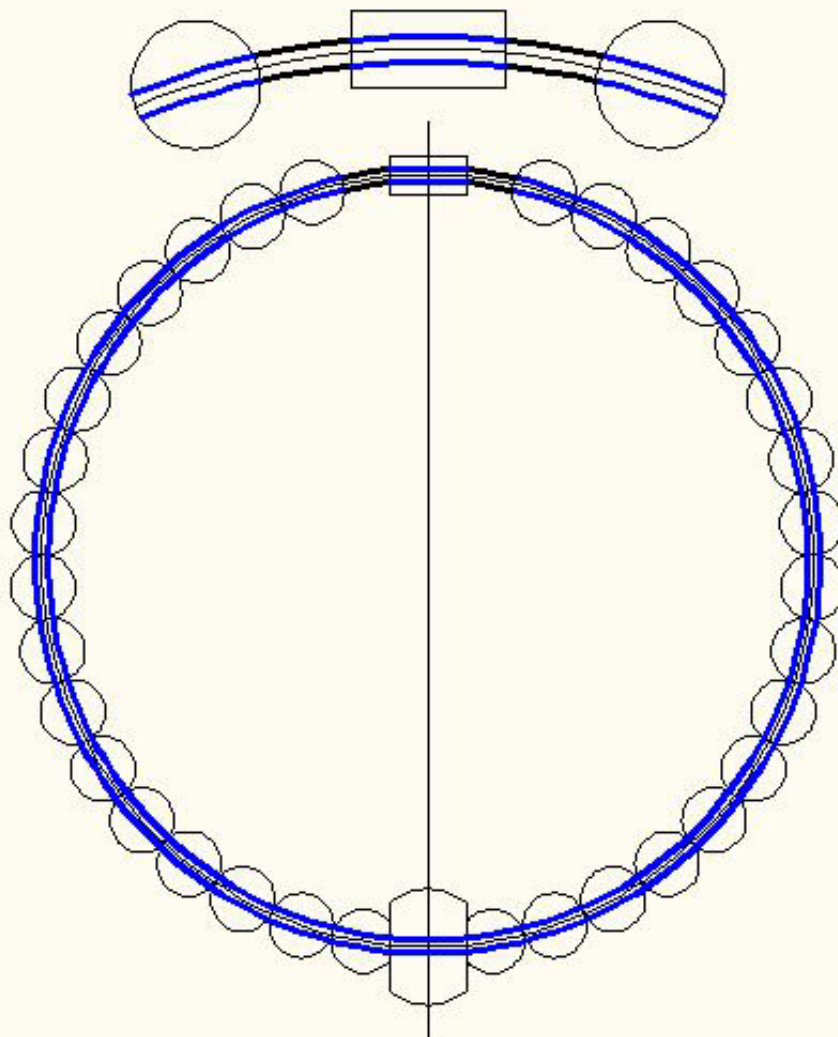

# Bracciale in 2D

VISTA DALL' ALTO

Prof. Pisani Antonio

10

- 1) C. LINEA —
- 2) C. RUOTA  $19^\circ$

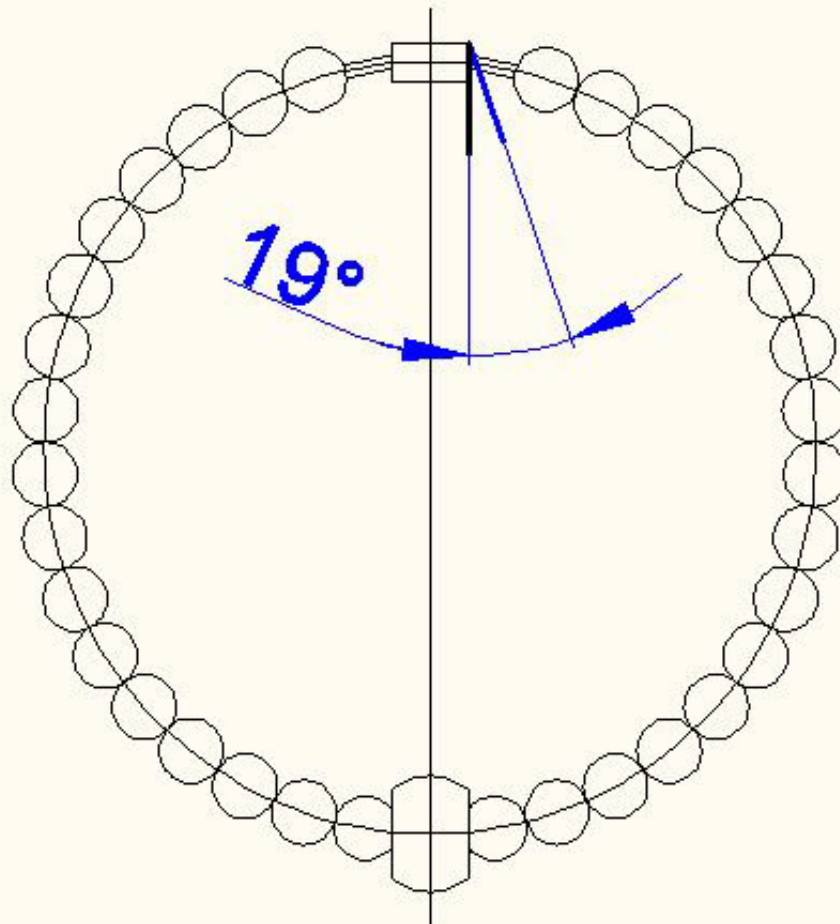

# Bracciale in 2D

VISTA DALL' ALTO

Prof. Pisani Antonio

11

- 1) C. LINEA —
- 2) C. OFFSET —
- 1) C. CERCHIO —

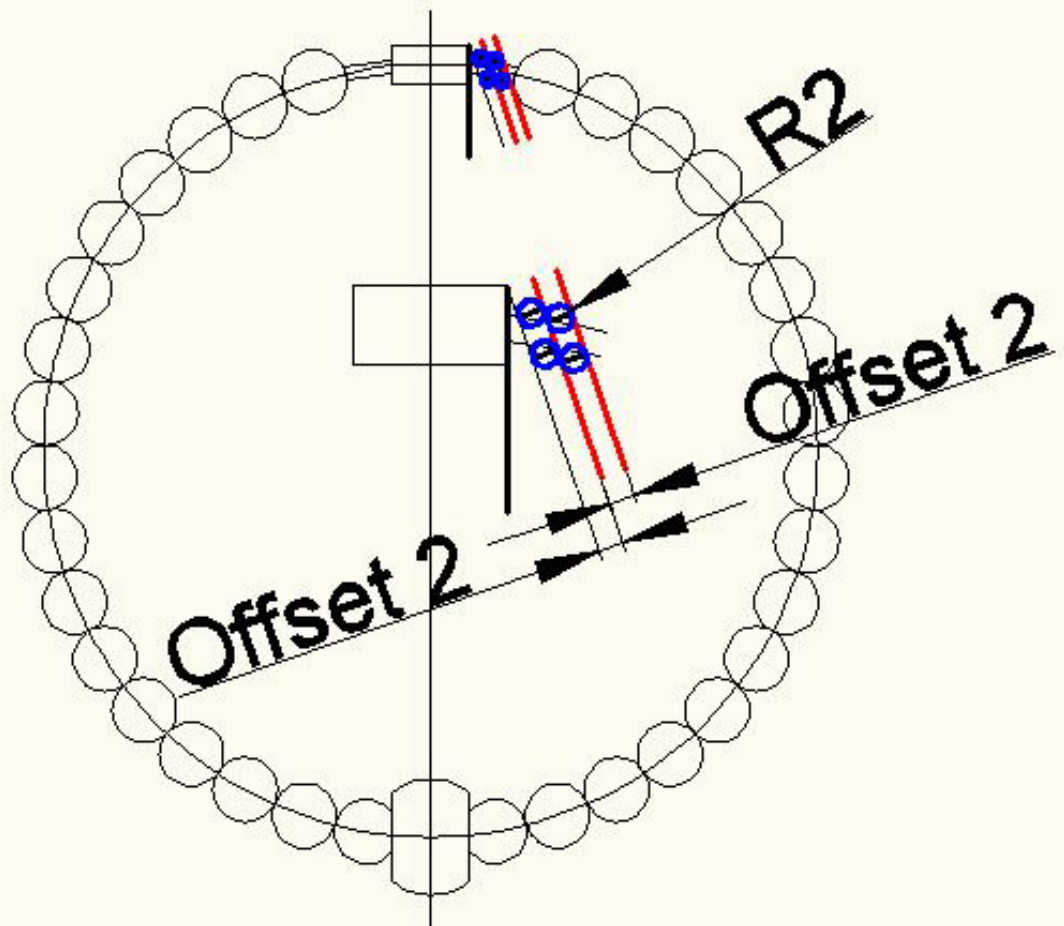

# Bracciale in 2D

VISTA DALL' ALTO

Prof. Pisani Antonio

12

1) C. LINEA



2) C. OFFSET

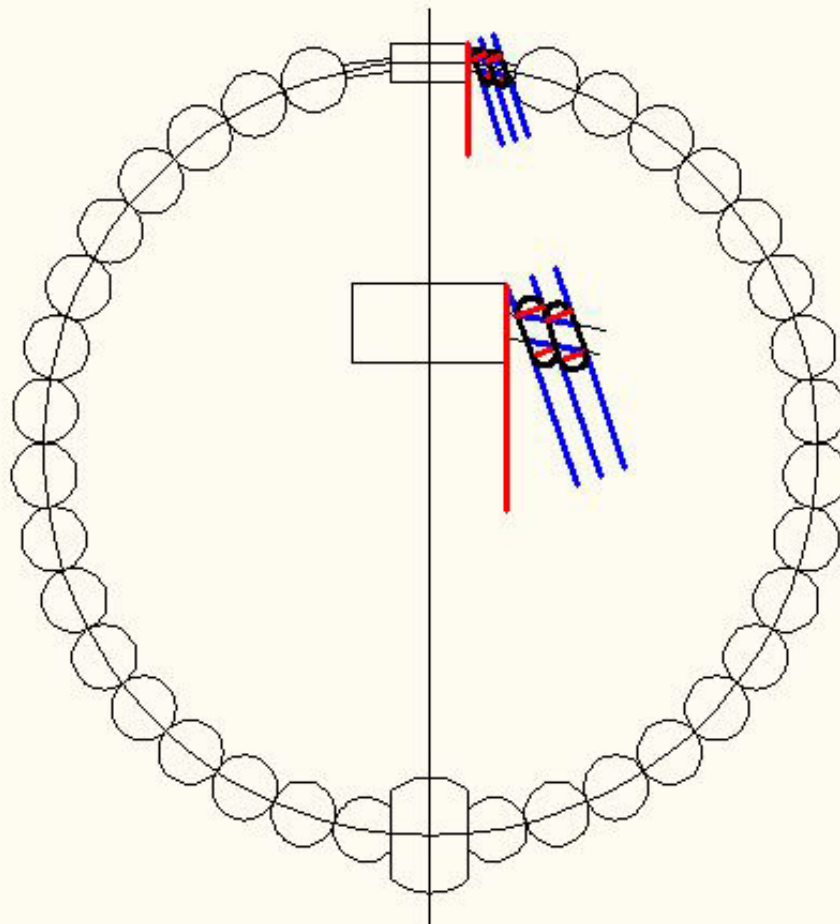

# Bracciale in 2D

VISTA DALL' ALTO

Prof. Pisani Antonio

13

1) C. SPECCHIO

2) C. TAGLIA

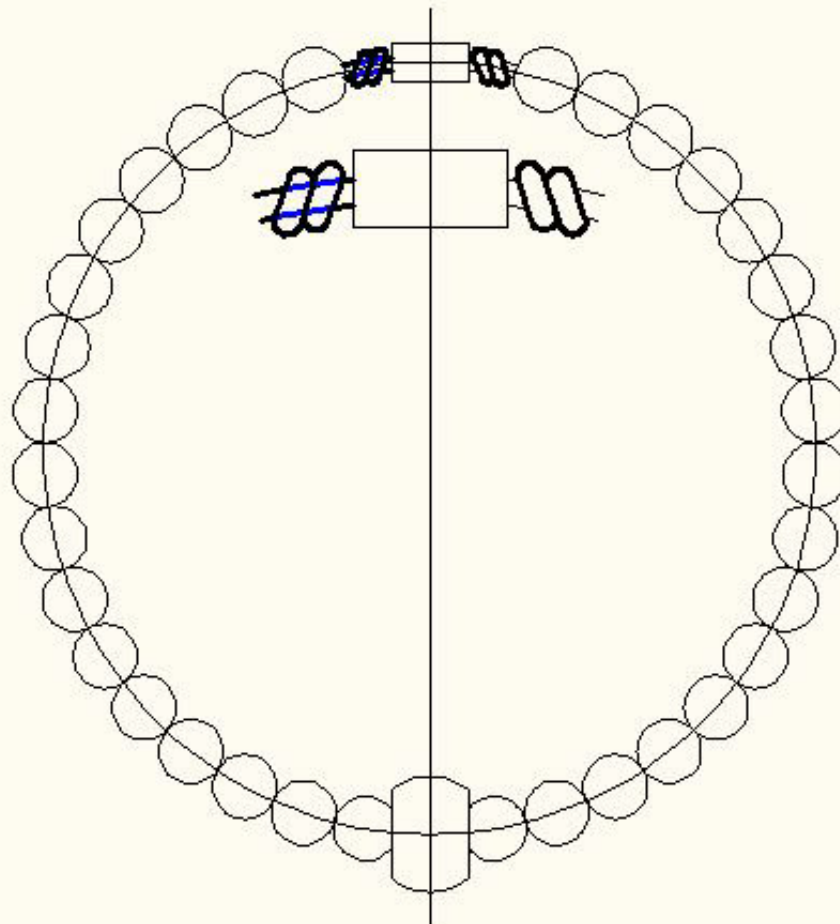

# Bracciale in 2D

VISTA DALL' ALTO

Prof. Pisani Antonio

14

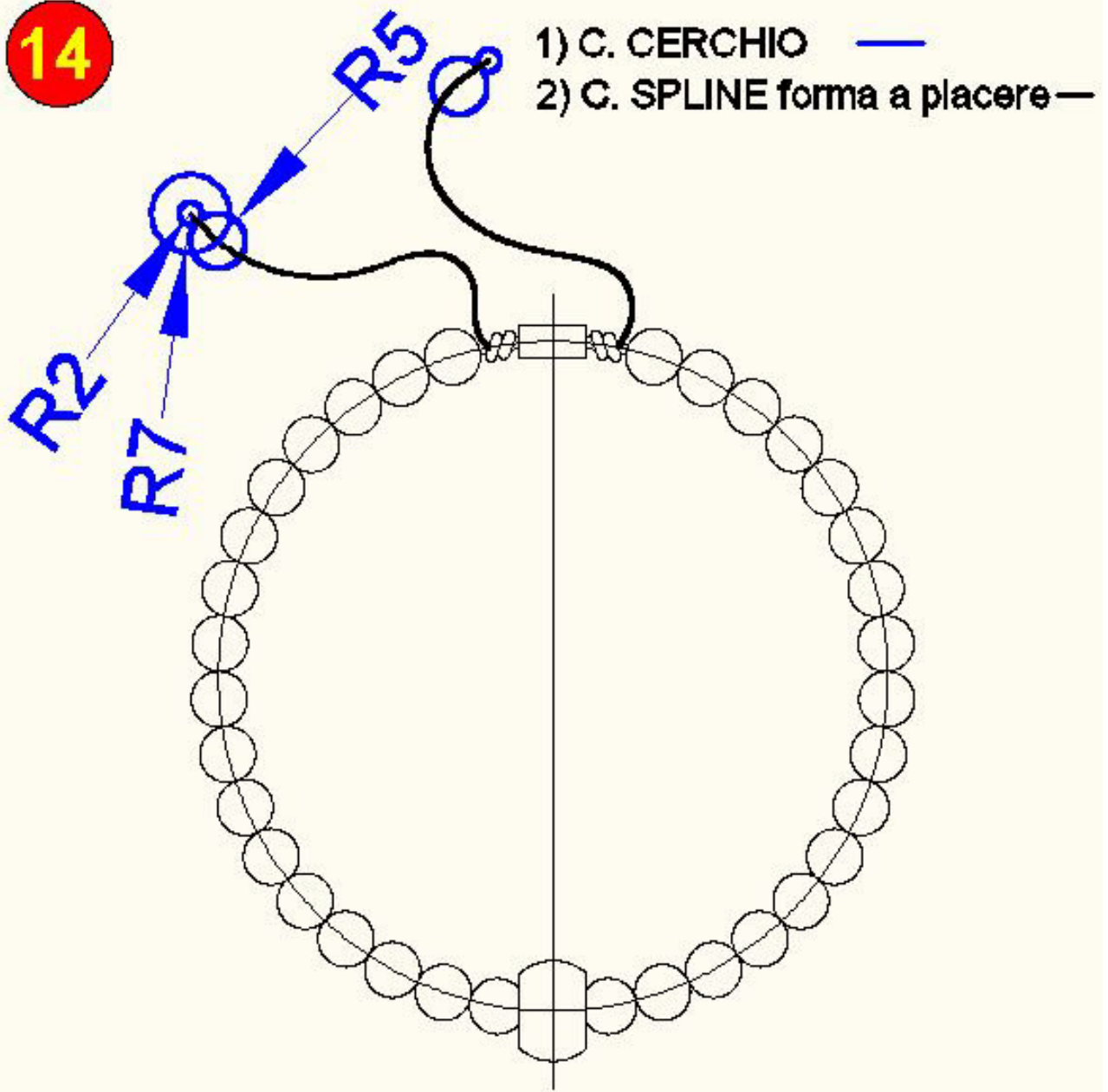

# Bracciale in 2D

VISTA DALL' ALTO

Prof. Pisani Antonio

15

1) C. OFFSET 1

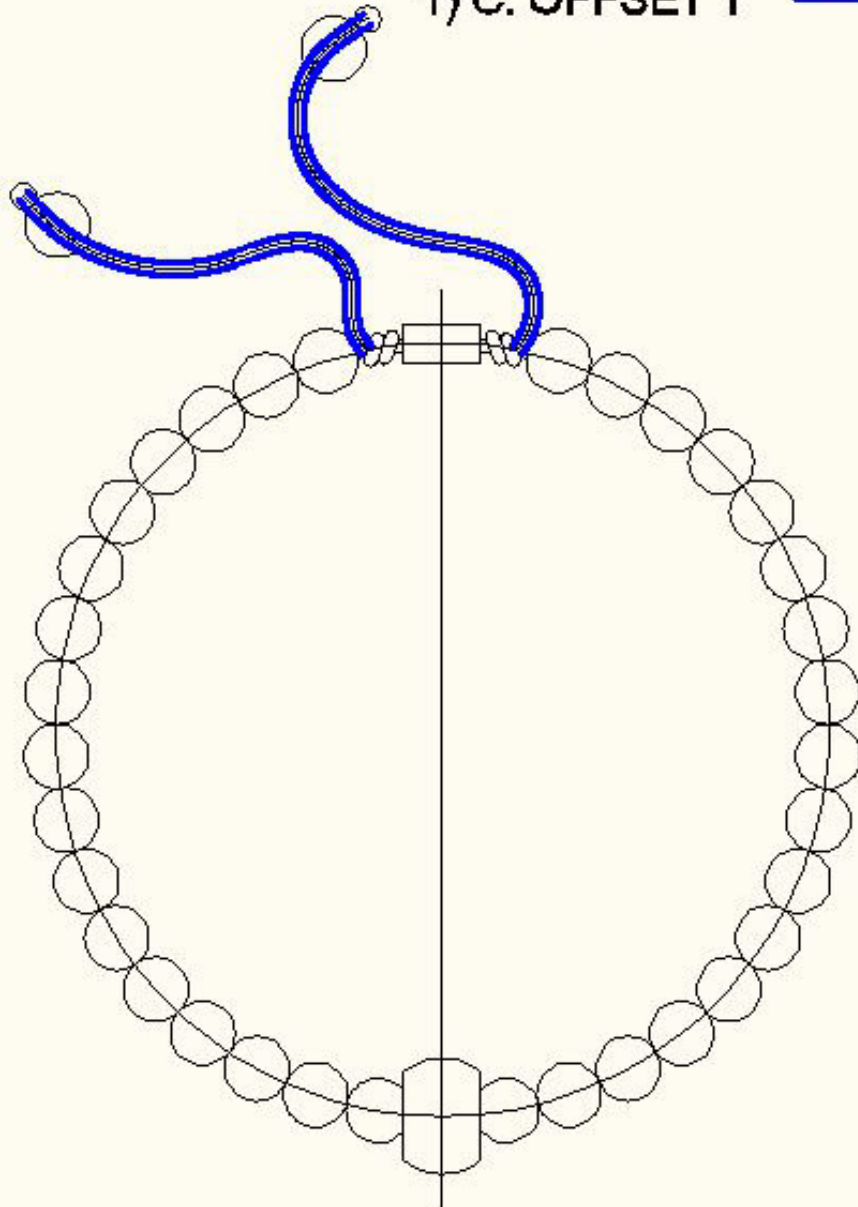



# Bracciale in 2D

VISTA DALL' ALTO

Prof. Pisani Antonio

16

- 1) C. TAGLIA —
- 2) C. CANCELLA —

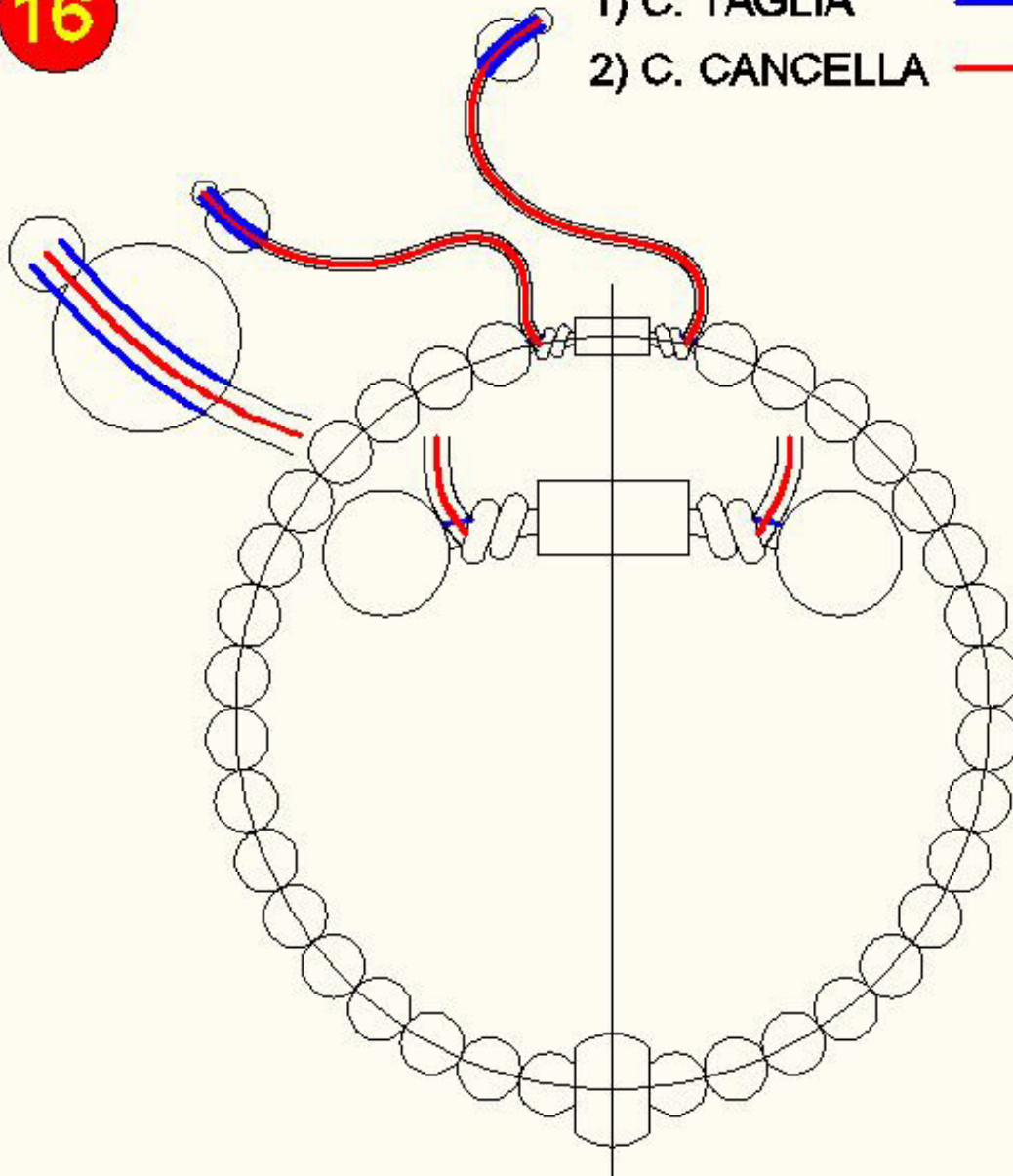

# Bracciale in 2D

VISTA DALL' ALTO

Prof. Pisani Antonio

17

1) C. TAGLIA



2) C. CANCELLA

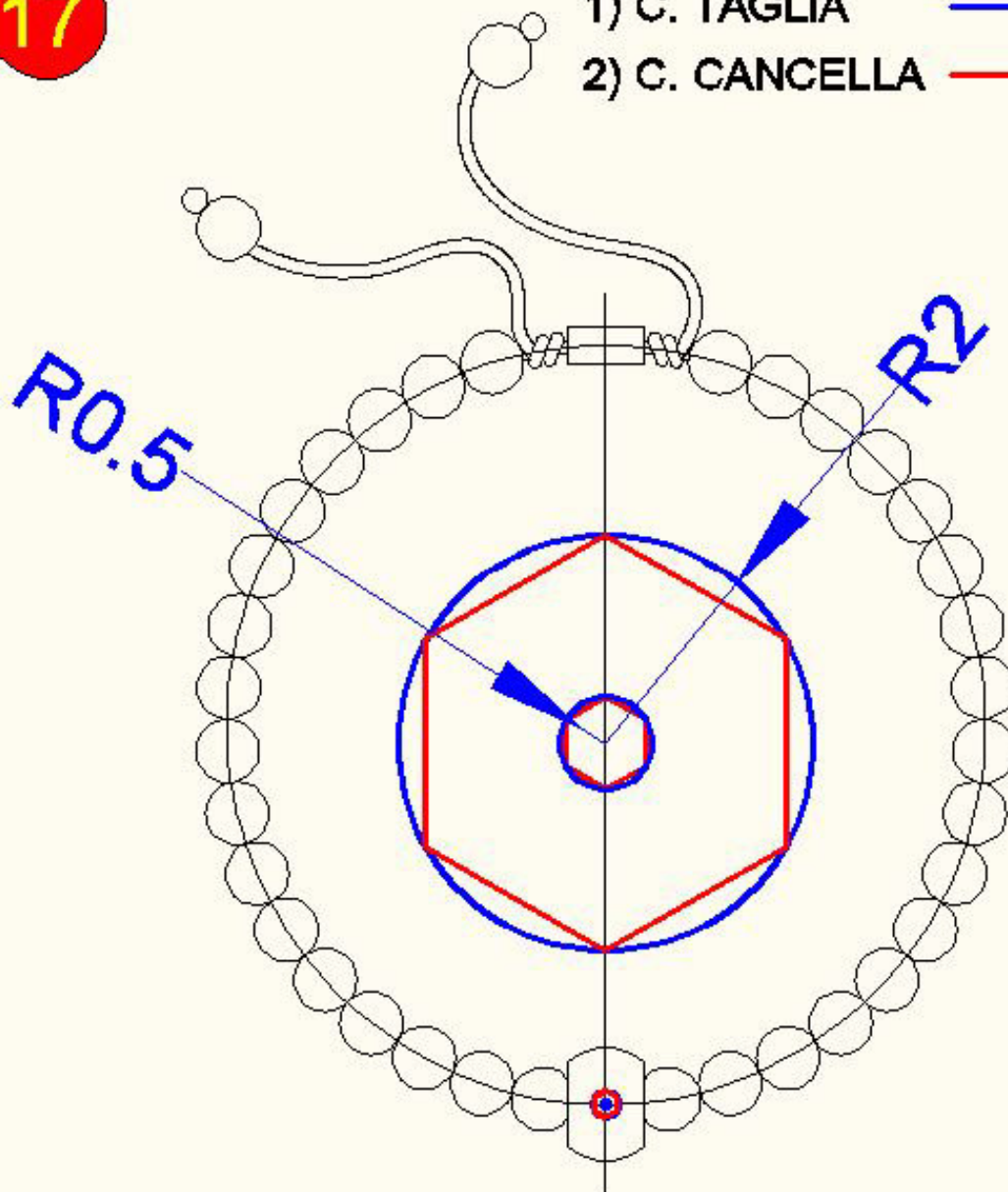

# Bracciale in 2D

VISTA DALL' ALTO

Prof. Pisani Antonio

18

1) C. LINEA

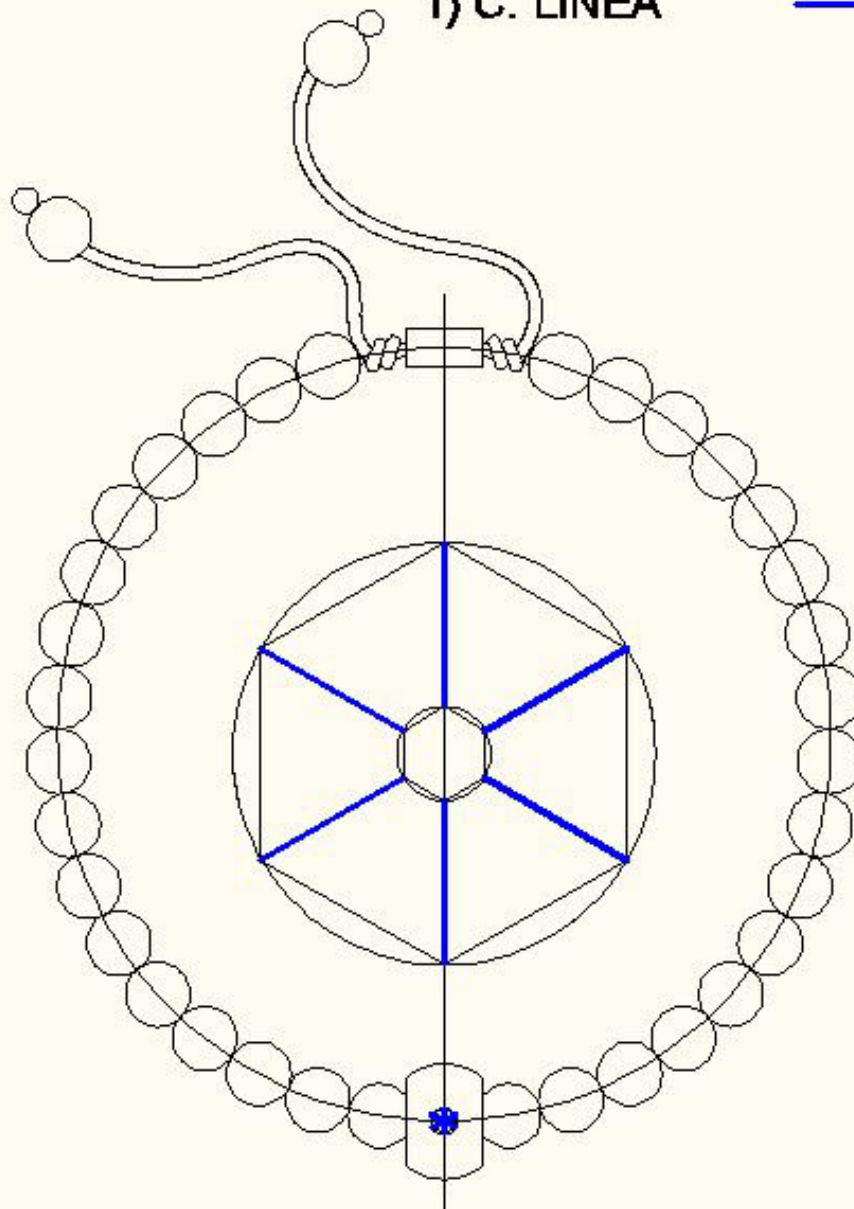

# Bracciale in 2D

VISTA DALL' ALTO

Prof. Pisani Antonio

19

- 1) C. CERCHIO —
- 2) C. ELLISSE —
- 5) Cancellare i cerchi

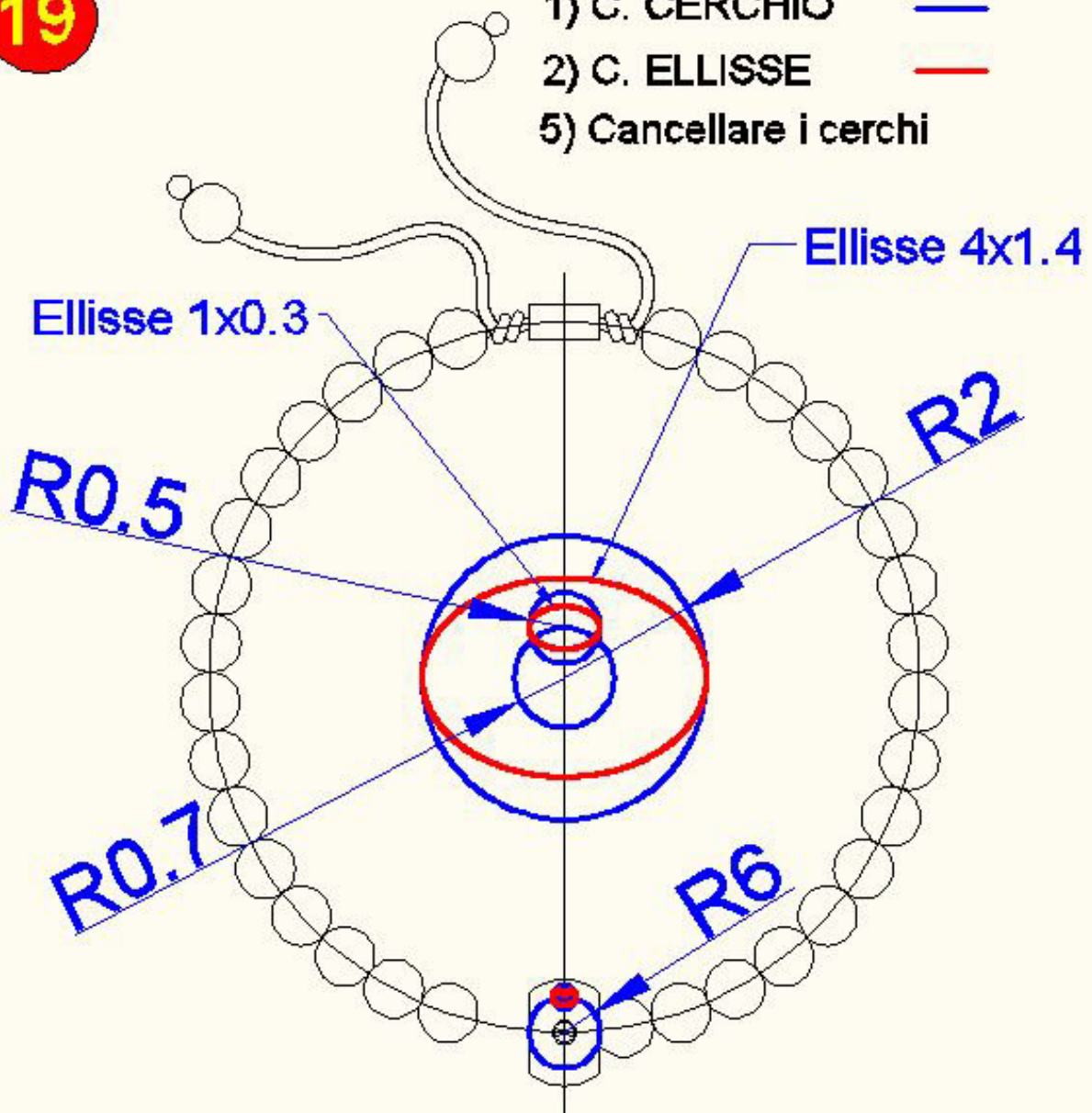

# Bracciale in 2D

VISTA DALL' ALTO

Prof. Pisani Antonio

20

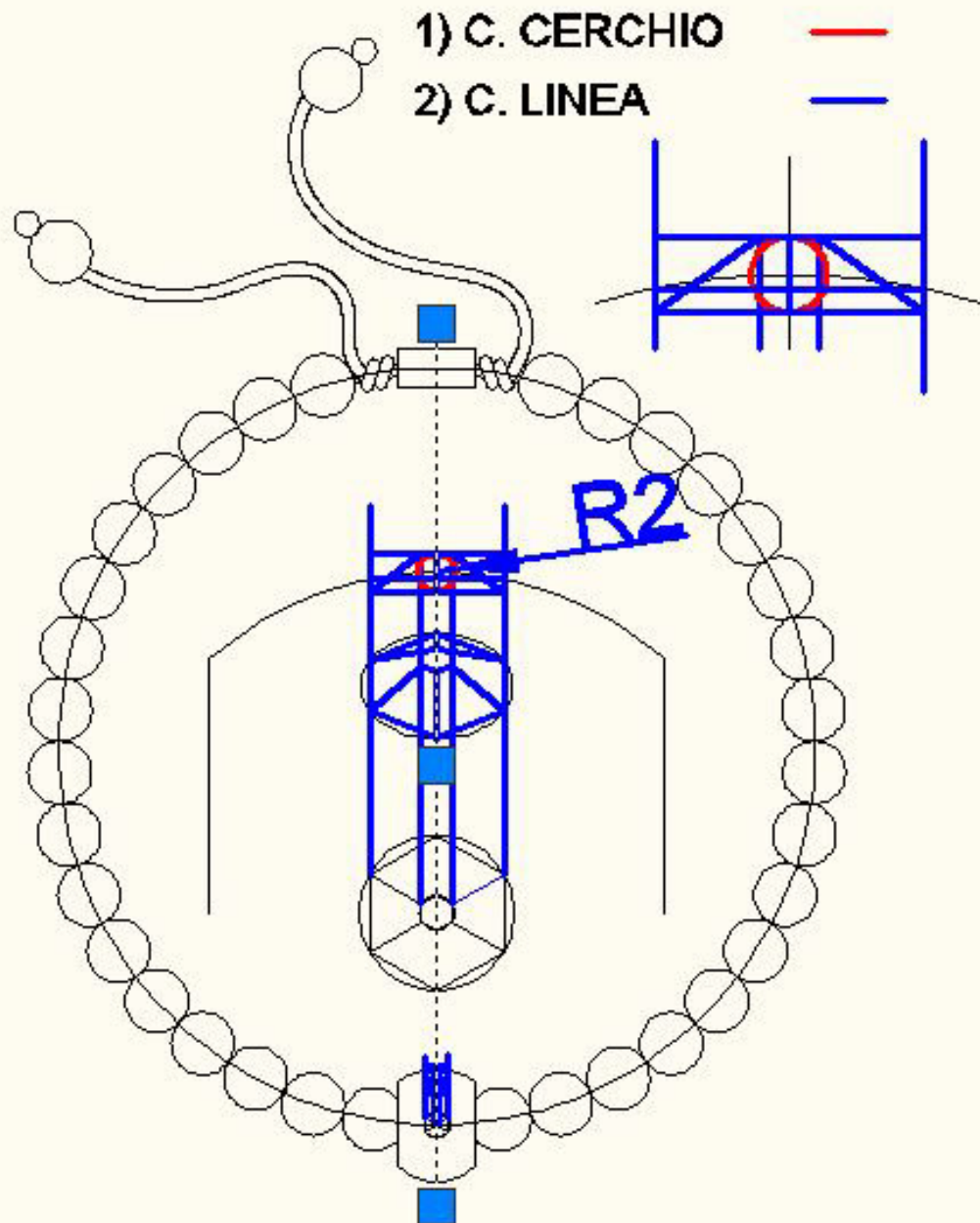

# Bracciale in 2D

VISTA DALL' ALTO

Prof. Pisani Antonio

21

1) C. TAGLIA



2) C. CANCELLA

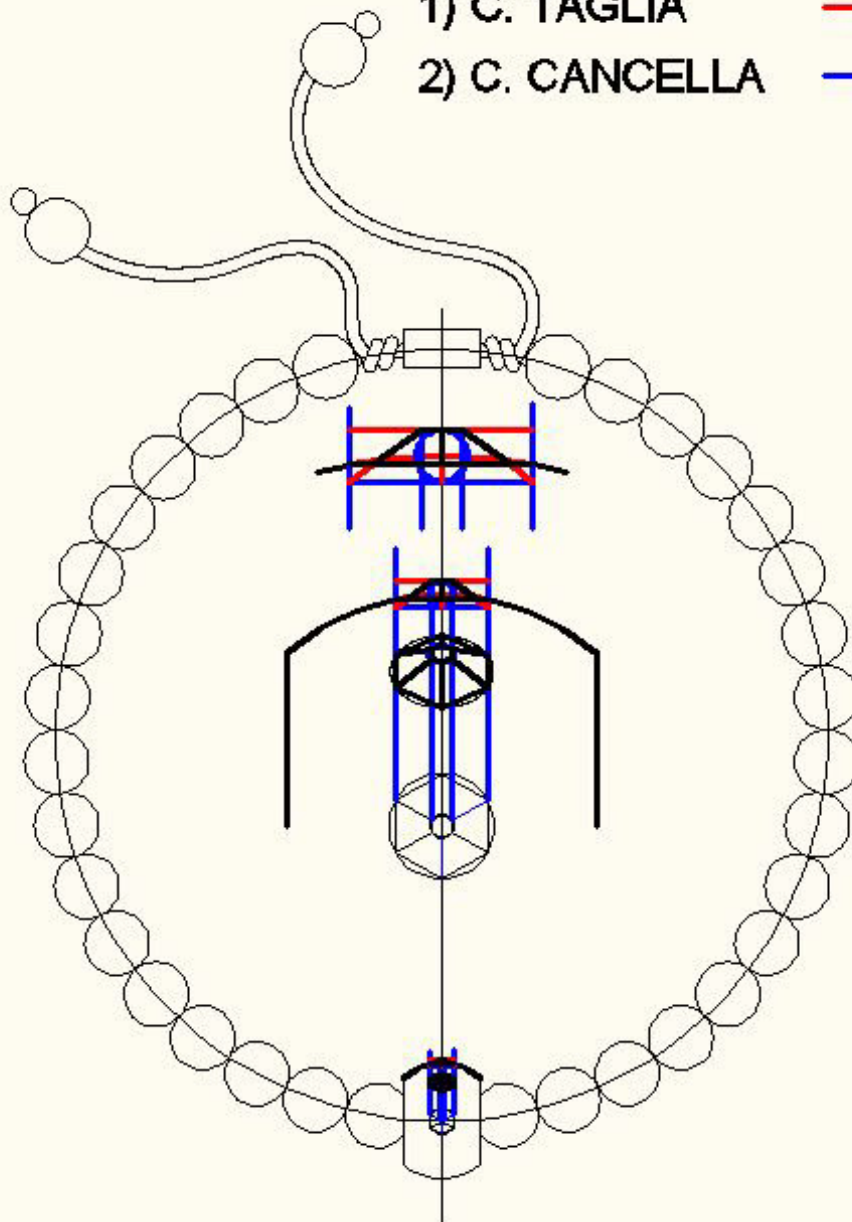

# Bracciale in 2D

VISTA DALL' ALTO

Prof. Pisani Antonio

22

1) C. CERCHIO —

2) C. COPIA Ellisse

3) Cancella cerchio

Copia Ellisse

R0.3

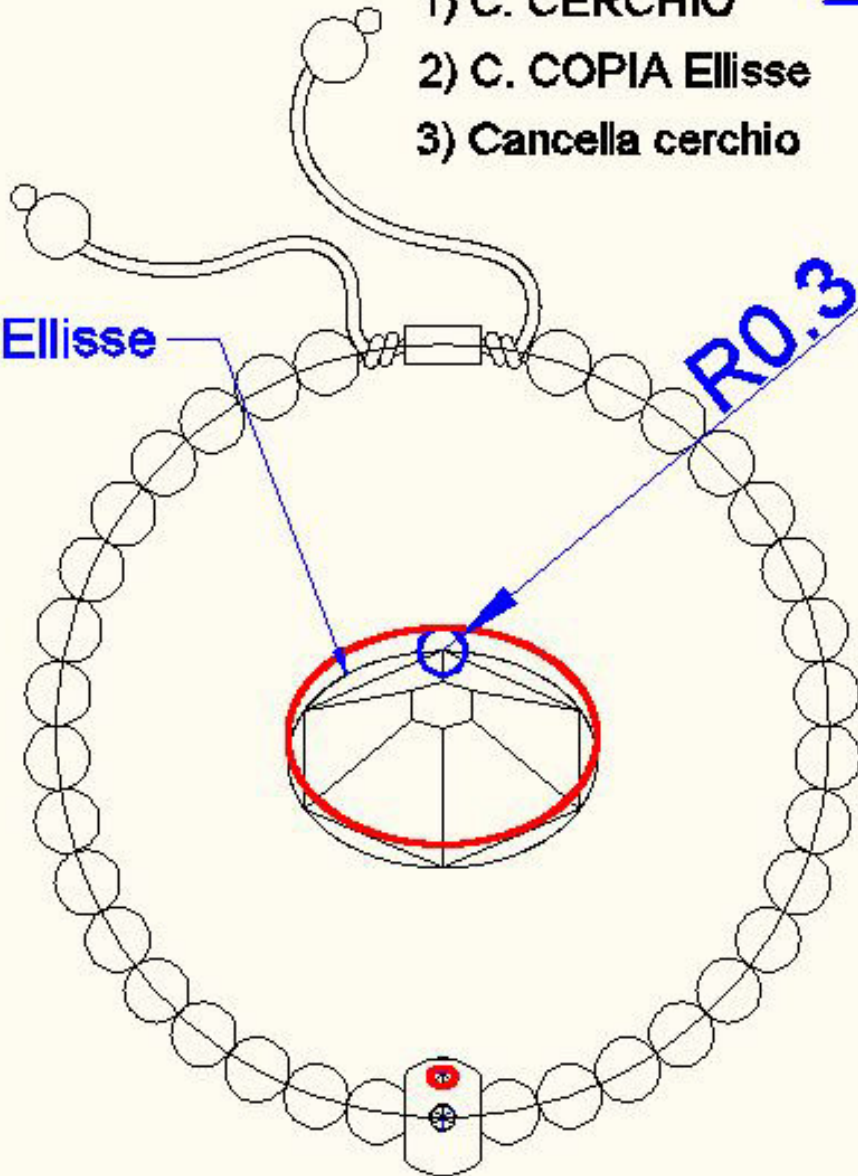

# Bracciale in 2D

VISTA DALL' ALTO

Prof. Pisani Antonio

23

1) C. CANCELLA



2) C. TAGLIA

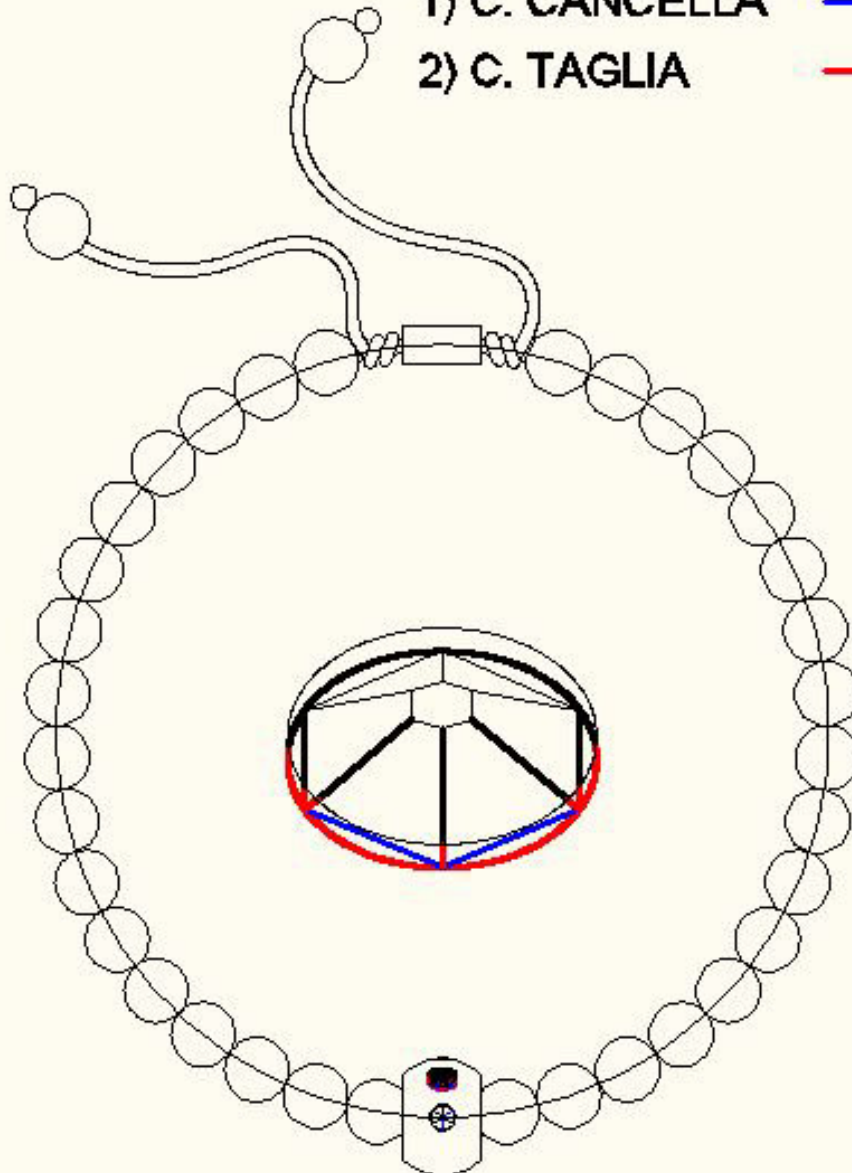



# Bracciale in 2D

VISTA DALL' ALTO

Prof. Pisani Antonio

24

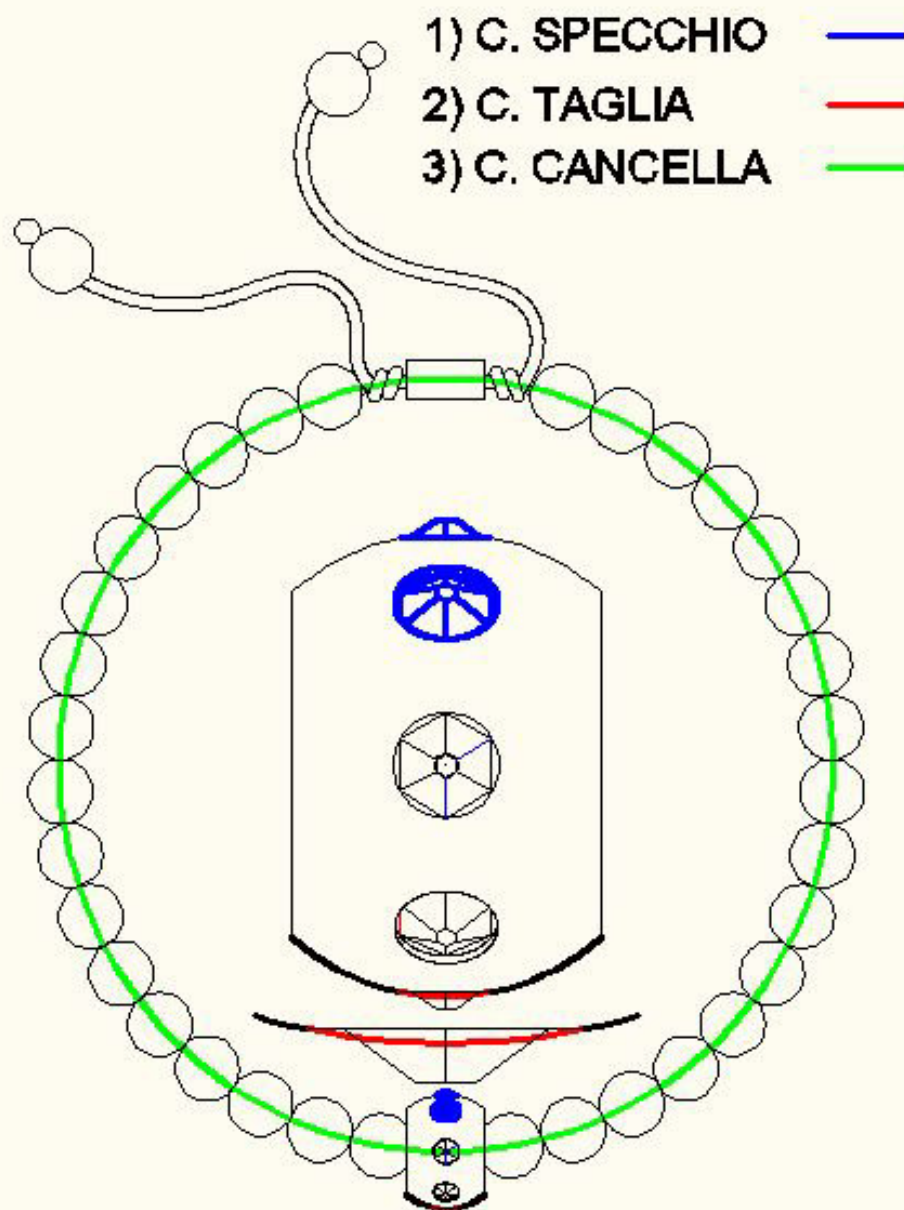

# Bracciale in 2D

VISTA DALL' ALTO

Prof. Pisani Antonio

25

1) C. TESTO MULTILINEE

2) COLORARE

3) REGIONE

3) SOTTRAI Esagono - Ellisse

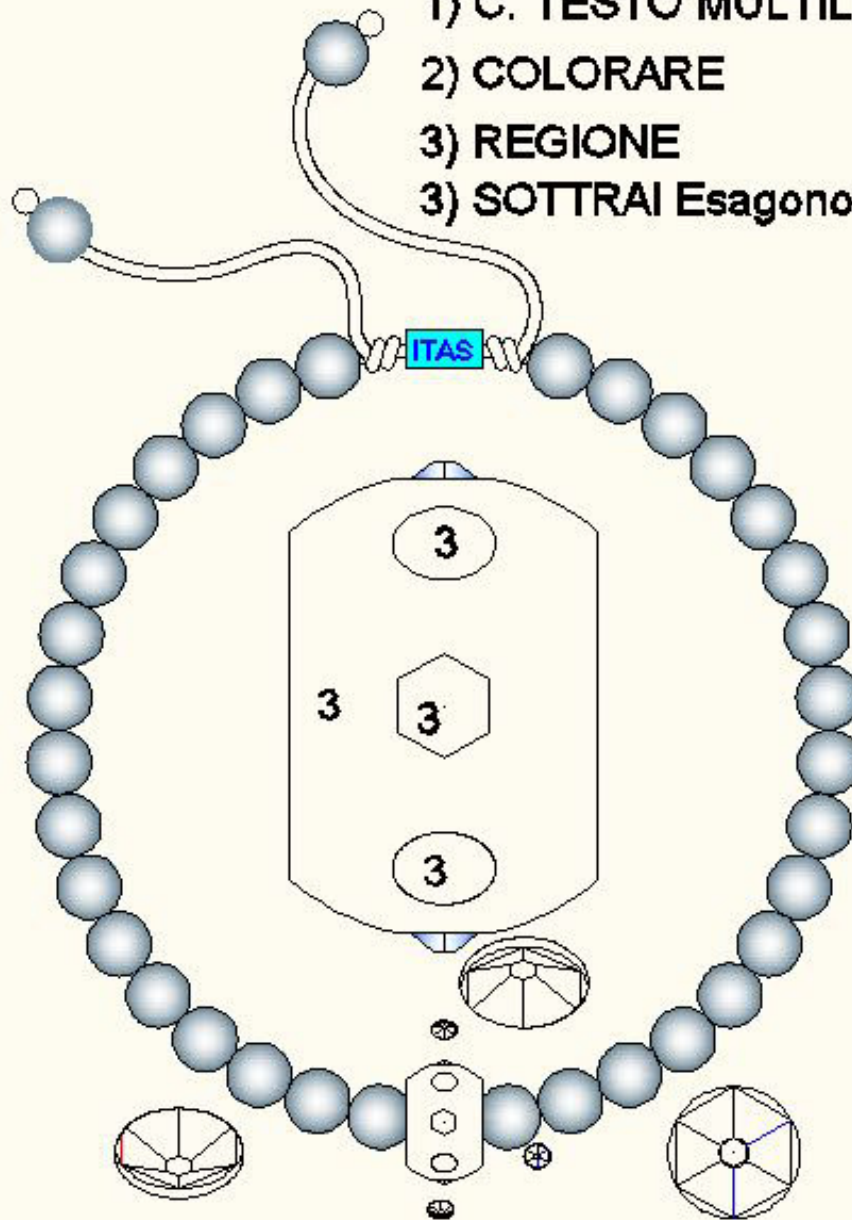

# Bracciale in 2D

VISTA DALL' ALTO

Prof. Pisani Antonio

26

1) COLORARE

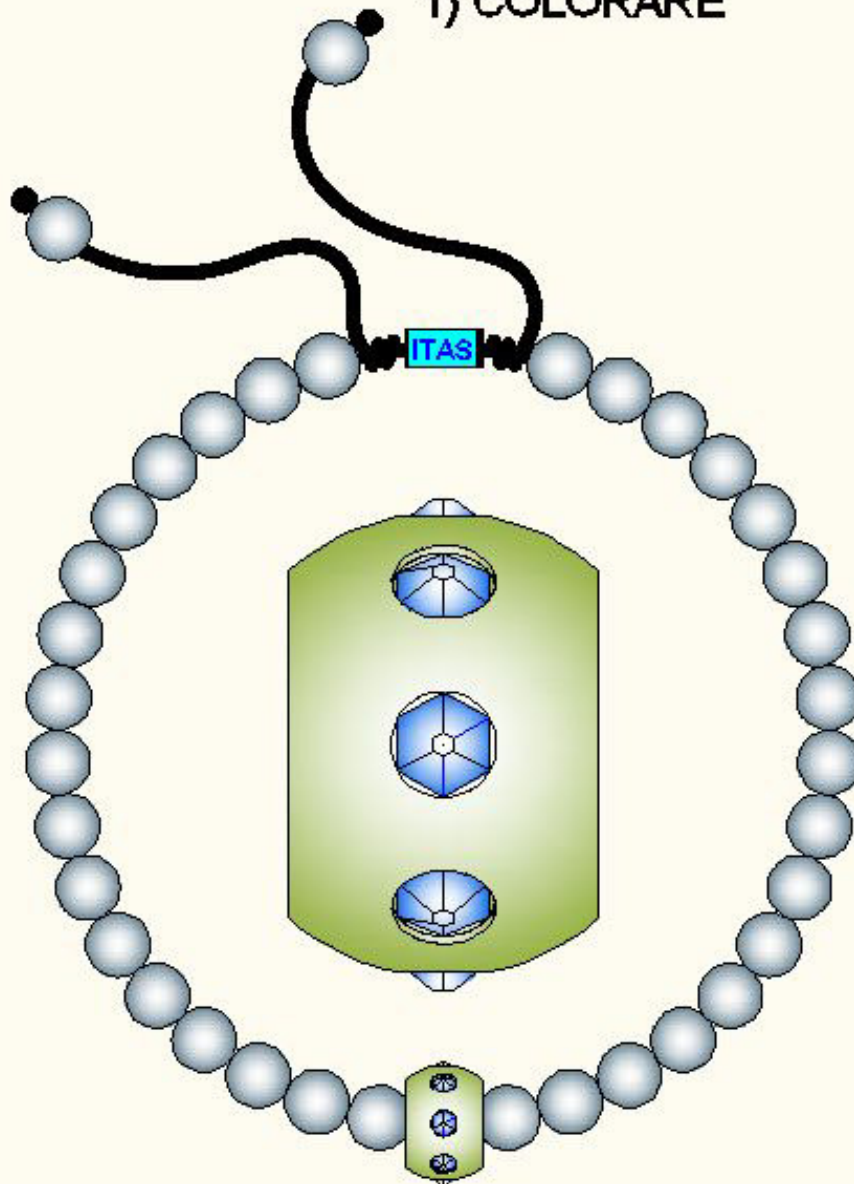

# Bracciale in 2D

VISTA DALL' ALTO

Prof. Pisani Antonio

27

RISULTATO FINALE

